

6. DYNAMIC PROGRAMMING I

- ▶ *weighted interval scheduling*
- ▶ *segmented least squares*
- ▶ *knapsack problem*
- ▶ *RNA secondary structure*

Lecture slides by Kevin Wayne

Copyright © 2005 Pearson–Addison Wesley

<http://www.cs.princeton.edu/~wayne/kleinberg-tardos>

Last updated on 2/10/21 2:39 PM

Algorithmic paradigms

Greed. Process the input in some order, myopically making irrevocable decisions.

Divide-and-conquer. Break up a problem into **independent** subproblems; solve each subproblem; combine solutions to subproblems to form solution to original problem.

Dynamic programming. Break up a problem into a series of **overlapping** subproblems; combine solutions to smaller subproblems to form solution to large subproblem.

fancy name for
caching intermediate results
in a table for later reuse

2

Dynamic programming history

Bellman. Pioneered the systematic study of dynamic programming in 1950s.

Etymology.

- Dynamic programming = planning over time.
- Secretary of Defense had pathological fear of mathematical research.
- Bellman sought a “dynamic” adjective to avoid conflict.



THE THEORY OF DYNAMIC PROGRAMMING

RICHARD BELLMAN

1. **Introduction.** Before turning to a discussion of some representative problems which will permit us to exhibit various mathematical features of the theory, let us present a brief survey of the fundamental concepts, hopes, and aspirations of dynamic programming.

To begin with, the theory was created to treat the mathematical problems arising from the study of various multi-stage decision processes, which may roughly be described in the following way: We have a physical system whose state at any time t is determined by a set of quantities which we call state parameters, or state variables. At certain times, which may be prescribed in advance, or which may be determined by the process itself, we are called upon to make decisions which will affect the state of the system. These decisions are equivalent to transformations of the state variables, the choice of a decision being identical with the choice of a transformation. The outcome of the preceding decisions is to be used to guide the choice of future ones, with the purpose of the whole process that of maximizing some function of the parameters describing the final state.

Examples of processes fitting this loose description are furnished by virtually every phase of modern life, from the planning of industrial production lines to the scheduling of patients at a medical clinic; from the determination of long-term investment programs for universities to the determination of a replacement policy for machinery in factories; from the programming of training policies for skilled and unskilled labor to the choice of optimal purchasing and inventory policies for department stores and military establishments.

3

Dynamic programming applications

Application areas.

- Computer science: AI, compilers, systems, graphics, theory,
- Operations research.
- Information theory.
- Control theory.
- Bioinformatics.

Some famous dynamic programming algorithms.

- Avidan–Shamir for seam carving.
- Unix diff for comparing two files.
- Viterbi for hidden Markov models.
- De Boor for evaluating spline curves.
- Bellman–Ford–Moore for shortest path.
- Knuth–Plass for word wrapping text in $T_{E}X$.
- Cocke–Kasami–Younger for parsing context-free grammars.
- Needleman–Wunsch/Smith–Waterman for sequence alignment.

4

Dynamic programming books

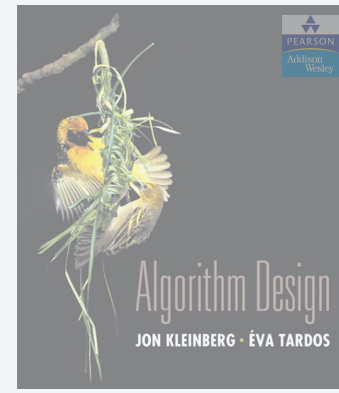

SECTIONS 6.1–6.2

6. DYNAMIC PROGRAMMING I

- ▶ *weighted interval scheduling*
- ▶ *segmented least squares*
- ▶ *knapsack problem*
- ▶ *RNA secondary structure*

Weighted interval scheduling

- Job j starts at s_j , finishes at f_j , and has weight $w_j > 0$.
- Two jobs are **compatible** if they don't overlap.
- Goal: find max-weight subset of mutually compatible jobs.

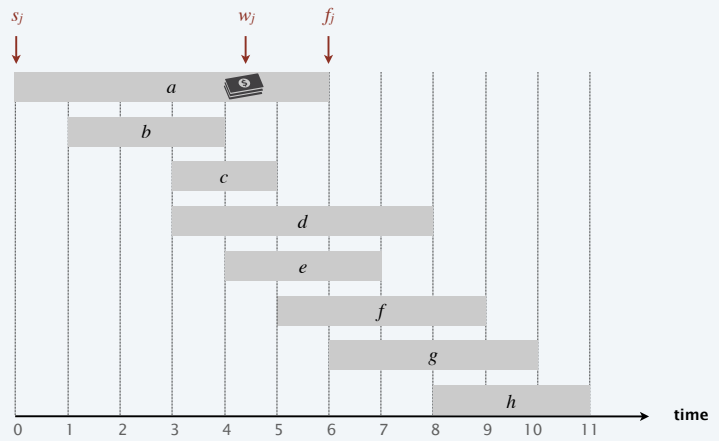

Earliest-finish-time first algorithm

Earliest finish-time first.

- Consider jobs in ascending order of finish time.
- Add job to subset if it is compatible with previously chosen jobs.

Recall. Greedy algorithm is correct if all weights are 1.

Observation. Greedy algorithm fails spectacularly for weighted version.

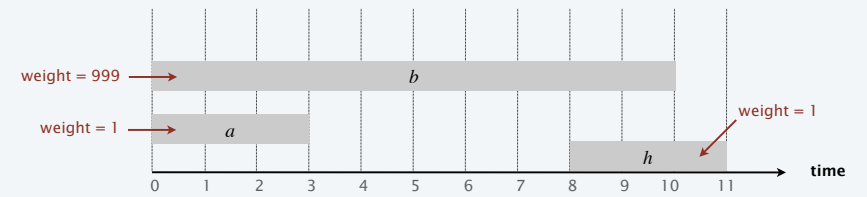

Weighted interval scheduling

Convention. Jobs are in ascending order of finish time: $f_1 \leq f_2 \leq \dots \leq f_n$.

Def. $p(j)$ = largest index $i < j$ such that job i is compatible with j .

Ex. $p(8) = 1, p(7) = 3, p(2) = 0$.

i is rightmost interval that ends before j begins

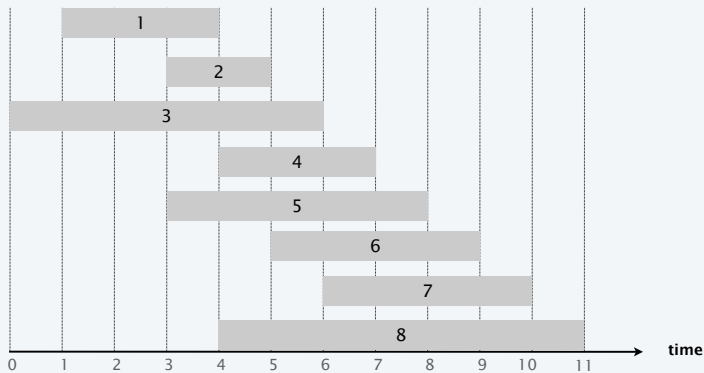

9

Dynamic programming: binary choice

Def. $OPT(j)$ = max weight of any subset of mutually compatible jobs for subproblem consisting only of jobs $1, 2, \dots, j$.

Goal. $OPT(n)$ = max weight of any subset of mutually compatible jobs.

Case 1. $OPT(j)$ does not select job j .

- Must be an optimal solution to problem consisting of remaining jobs $1, 2, \dots, j-1$.

optimal substructure property (proof via exchange argument)

Case 2. $OPT(j)$ selects job j .

- Collect profit w_j .
- Can't use incompatible jobs $\{p(j)+1, p(j)+2, \dots, j-1\}$.
- Must include optimal solution to problem consisting of remaining compatible jobs $1, 2, \dots, p(j)$.

Bellman equation. $OPT(j) = \begin{cases} 0 & \text{if } j = 0 \\ \max\{OPT(j-1), w_j + OPT(p(j))\} & \text{if } j > 0 \end{cases}$

10

Weighted interval scheduling: brute force

BRUTE-FORCE ($n, s_1, \dots, s_n, f_1, \dots, f_n, w_1, \dots, w_n$)

Sort jobs by finish time and renumber so that $f_1 \leq f_2 \leq \dots \leq f_n$.

Compute $p[1], p[2], \dots, p[n]$ via binary search.

RETURN COMPUTE-OPT(n).

COMPUTE-OPT(j)

IF ($j = 0$)

RETURN 0.

ELSE

RETURN $\max\{\text{COMPUTE-OPT}(j-1), w_j + \text{COMPUTE-OPT}(p[j])\}$.

11

Dynamic programming: quiz 1



What is running time of COMPUTE-OPT(n) in the worst case?

- A.** $\Theta(n \log n)$
- B.** $\Theta(n^2)$
- C.** $\Theta(1.618^n)$
- D.** $\Theta(2^n)$

COMPUTE-OPT(j)

IF ($j = 0$)

RETURN 0.

ELSE

RETURN $\max\{\text{COMPUTE-OPT}(j-1), w_j + \text{COMPUTE-OPT}(p[j])\}$.

12

Weighted interval scheduling: brute force

Observation. Recursive algorithm is spectacularly slow because of overlapping subproblems \Rightarrow exponential-time algorithm.

Ex. Number of recursive calls for family of “layered” instances grows like Fibonacci sequence.

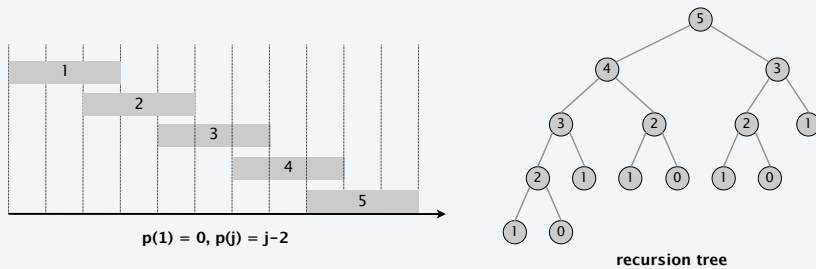

13

Weighted interval scheduling: memoization

Top-down dynamic programming (memoization).

- Cache result of subproblem j in $M[j]$.
- Use $M[j]$ to avoid solving subproblem j more than once.

TOP-DOWN($n, s_1, \dots, s_n, f_1, \dots, f_n, w_1, \dots, w_n$)

Sort jobs by finish time and renumber so that $f_1 \leq f_2 \leq \dots \leq f_n$.

Compute $p[1], p[2], \dots, p[n]$ via binary search.

$M[0] \leftarrow 0$. \leftarrow global array

RETURN M-COMPUTE-OPT(n).

M-COMPUTE-OPT(j)

IF ($M[j]$ is uninitialized)

$M[j] \leftarrow \max \{ \text{M-COMPUTE-OPT}(j-1), w_j + \text{M-COMPUTE-OPT}(p[j]) \}$.

RETURN $M[j]$.

14

Weighted interval scheduling: running time

Claim. Memoized version of algorithm takes $O(n \log n)$ time.

Pf.

- Sort by finish time: $O(n \log n)$ via mergesort.
- Compute $p[j]$ for each j : $O(n \log n)$ via binary search.
- M-COMPUTE-OPT(j): each invocation takes $O(1)$ time and either
 - (1) returns an initialized value $M[j]$
 - (2) initializes $M[j]$ and makes two recursive calls
- Progress measure $\Phi = \#$ initialized entries among $M[1..n]$.
 - initially $\Phi = 0$; throughout $\Phi \leq n$.
 - (2) increases Φ by 1 $\Rightarrow \leq 2n$ recursive calls.
- Overall running time of M-COMPUTE-OPT(n) is $O(n)$. ■

15

Those who cannot remember the past are condemned to repeat it.

- Dynamic Programming

Weighted interval scheduling: finding a solution

Q. DP algorithm computes optimal value. How to find optimal solution?

A. Make a second pass by calling `FIND-SOLUTION(n)`.

```
FIND-SOLUTION( $j$ )
```

```
IF ( $j = 0$ )
```

```
  RETURN  $\emptyset$ .
```

```
ELSE IF ( $w_j + M[p[j]] > M[j-1]$ )
```

```
  RETURN  $\{j\} \cup \text{FIND-SOLUTION}(p[j])$ .
```

```
ELSE
```

```
  RETURN FIND-SOLUTION( $j-1$ ).
```

$$M[j] = \max \{ M[j-1], w_j + M[p[j]] \}.$$

Analysis. # of recursive calls $\leq n \Rightarrow O(n)$.

17

Weighted interval scheduling: bottom-up dynamic programming

Bottom-up dynamic programming. Unwind recursion.

```
BOTTOM-UP( $n, s_1, \dots, s_n, f_1, \dots, f_n, w_1, \dots, w_n$ )
```

Sort jobs by finish time and renumber so that $f_1 \leq f_2 \leq \dots \leq f_n$.

Compute $p[1], p[2], \dots, p[n]$.

```
 $M[0] \leftarrow 0$ .
```

previously computed values

```
FOR  $j = 1$  TO  $n$ 
```

```
   $M[j] \leftarrow \max \{ M[j-1], w_j + M[p[j]] \}$ .
```

Running time. The bottom-up version takes $O(n \log n)$ time.

18

MAXIMUM SUBARRAY PROBLEM



Goal. Given an array x of n integer (positive or negative), find a contiguous subarray whose sum is maximum.

12	5	-1	31	-61	59	26	-53	58	97	-93	-23	84	-15	6
----	---	----	----	-----	----	----	-----	----	----	-----	-----	----	-----	---

187

Applications. Computer vision, data mining, genomic sequence analysis, technical job interviews,

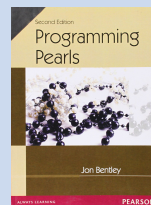

19

MAXIMUM SUBARRAY PROBLEM



Goal. Given an array x of n integer (positive or negative), find a contiguous subarray whose sum is maximum.

12	5	-1	31	-61	59	26	-53	58	97	-93	-23	84	-15	6
----	---	----	----	-----	----	----	-----	----	----	-----	-----	----	-----	---

187

Brute-force algorithm.

- For each i and j : compute $a[i] + a[i+1] + \dots + a[j]$.
- Takes $\Theta(n^3)$ time.

Apply "cumulative sum" trick.

- Precompute cumulative sums: $S[i] = a[0] + a[1] + \dots + a[i]$.
- Now $a[i] + a[i+1] + \dots + a[j] = S[j] - S[i-1]$.
- Improves running time $\Theta(n^2)$.

20

KADANE'S ALGORITHM



Def. $OPT(i) = \max$ sum of any subarray of x whose rightmost index is i .



Goal. $\max_i OPT(i)$

Bellman equation. $OPT(i) = \begin{cases} x_1 & \text{if } i = 1 \\ \max \{ x_i, x_i + OPT(i-1) \} & \text{if } i > 1 \end{cases}$

↑
take only
element i

↑
take element i
together with best subarray
ending at index $i-1$

Running time. $O(n)$.

21

MAXIMUM RECTANGLE PROBLEM



Goal. Given an n -by- n matrix A , find a rectangle whose sum is maximum.

$$A = \begin{bmatrix} -2 & 5 & 0 & -5 & -2 & 2 & -3 \\ 4 & -3 & -1 & 3 & 2 & 1 & -1 \\ -5 & 6 & 3 & -5 & -1 & -4 & -2 \\ -1 & -1 & 3 & -1 & 4 & 1 & 1 \\ 3 & -3 & 2 & 0 & 3 & -3 & -2 \\ -2 & 1 & -2 & 1 & 1 & 3 & -1 \\ 2 & -4 & 0 & 1 & 0 & -3 & -1 \end{bmatrix}$$

13

Applications. Databases, image processing, maximum likelihood estimation, technical job interviews, ...

22

BENTLEY'S ALGORITHM



Assumption. Suppose you knew the left and right column indices j and j' .

$$A = \begin{bmatrix} -2 & 5 & 0 & -5 & -2 & 2 & -3 \\ 4 & -3 & -1 & 3 & 2 & 1 & -1 \\ -5 & 6 & 3 & -5 & -1 & -4 & -2 \\ -1 & -1 & 3 & -1 & 4 & 1 & 1 \\ 3 & -3 & 2 & 0 & 3 & -3 & -2 \\ -2 & 1 & -2 & 1 & 1 & 3 & -1 \\ 2 & -4 & 0 & 1 & 0 & -3 & -1 \end{bmatrix} \quad x = \begin{bmatrix} -7 \\ 4 \\ -3 \\ 6 \\ 5 \\ 0 \\ 1 \end{bmatrix}$$

↑ $0 - 5 - 2$

An $O(n^3)$ algorithm.

- Precompute cumulative row sums $S_{ij} = \sum_{k=1}^j A_{ik}$.
- For each $j < j'$:
 - define array x using row-sum differences: $x_i = S_{ij'} - S_{ij}$
 - run Kadane's algorithm in array x

↑ solve maximum
subarray problem
in this array

Open problem. $O(n^{3-\epsilon})$ for any constant $\epsilon > 0$.

23

6. DYNAMIC PROGRAMMING I

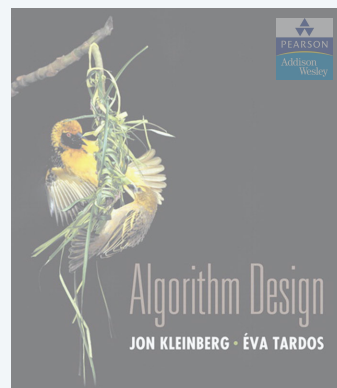

SECTION 6.3

- ▶ *weighted interval scheduling*
- ▶ *segmented least squares*
- ▶ *knapsack problem*
- ▶ *RNA secondary structure*

Least squares

Least squares. Foundational problem in statistics.

- Given n points in the plane: $(x_1, y_1), (x_2, y_2), \dots, (x_n, y_n)$.
- Find a line $y = ax + b$ that minimizes the sum of the squared error:

$$SSE = \sum_{i=1}^n (y_i - ax_i - b)^2$$

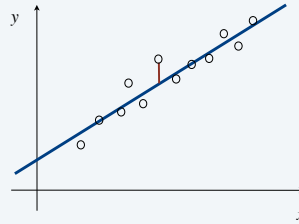

Solution. Calculus \Rightarrow min error is achieved when

$$a = \frac{n \sum_i x_i y_i - (\sum_i x_i)(\sum_i y_i)}{n \sum_i x_i^2 - (\sum_i x_i)^2}, \quad b = \frac{\sum_i y_i - a \sum_i x_i}{n}$$

25

Segmented least squares

Segmented least squares.

- Points lie roughly on a sequence of several line segments.
- Given n points in the plane: $(x_1, y_1), (x_2, y_2), \dots, (x_n, y_n)$ with $x_1 < x_2 < \dots < x_n$, find a sequence of lines that minimizes $f(x)$.

Q. What is a reasonable choice for $f(x)$ to balance accuracy and parsimony?

↑ goodness of fit ↑ number of lines

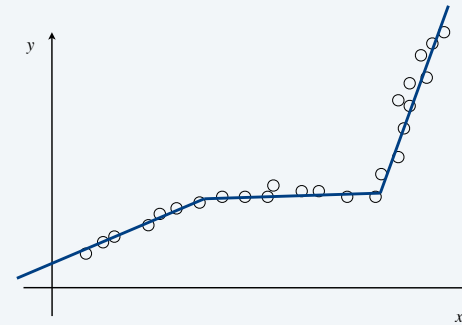

26

Segmented least squares

Segmented least squares.

- Points lie roughly on a sequence of several line segments.
- Given n points in the plane: $(x_1, y_1), (x_2, y_2), \dots, (x_n, y_n)$ with $x_1 < x_2 < \dots < x_n$, find a sequence of lines that minimizes $f(x)$.

Goal. Minimize $f(x) = E + cL$ for some constant $c > 0$, where

- E = sum of the sums of the squared errors in each segment.
- L = number of lines.

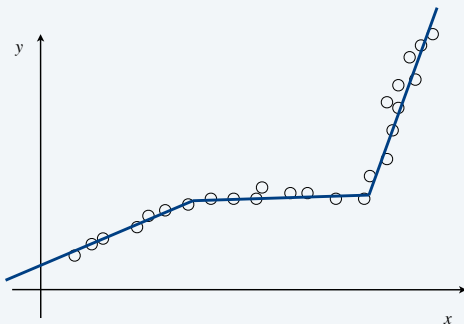

27

Dynamic programming: multiway choice

Notation.

- $OPT(j)$ = minimum cost for points p_1, p_2, \dots, p_j .
- e_{ij} = SSE for for points p_i, p_{i+1}, \dots, p_j .

To compute $OPT(j)$:

- Last segment uses points p_i, p_{i+1}, \dots, p_j for some $i \leq j$.
- Cost = $e_{ij} + c + OPT(i-1)$. ← optimal substructure property (proof via exchange argument)

Bellman equation.

$$OPT(j) = \begin{cases} 0 & \text{if } j = 0 \\ \min_{1 \leq i \leq j} \{ e_{ij} + c + OPT(i-1) \} & \text{if } j > 0 \end{cases}$$

28

Segmented least squares algorithm

SEGMENTED-LEAST-SQUARES(n, p_1, \dots, p_n, c)

FOR $j = 1$ TO n

 FOR $i = 1$ TO j

 Compute the SSE e_{ij} for the points p_i, p_{i+1}, \dots, p_j .

$M[0] \leftarrow 0$.

FOR $j = 1$ TO n

$M[j] \leftarrow \min_{1 \leq i \leq j} \{ e_{ij} + c + M[i-1] \}$.

previously computed value



RETURN $M[n]$.

29

Segmented least squares analysis

Theorem. [Bellman 1961] DP algorithm solves the segmented least squares problem in $O(n^3)$ time and $O(n^2)$ space.

Pf.

- Bottleneck = computing SSE e_{ij} for each i and j .

$$a_{ij} = \frac{n \sum_k x_k y_k - (\sum_k x_k)(\sum_k y_k)}{n \sum_k x_k^2 - (\sum_k x_k)^2}, \quad b_{ij} = \frac{\sum_k y_k - a_{ij} \sum_k x_k}{n}$$

- $O(n)$ to compute e_{ij} . ■

Remark. Can be improved to $O(n^2)$ time.

- For each i : precompute cumulative sums $\sum_{k=1}^i x_k, \sum_{k=1}^i y_k, \sum_{k=1}^i x_k^2, \sum_{k=1}^i x_k y_k$.
- Using cumulative sums, can compute e_{ij} in $O(1)$ time.

30

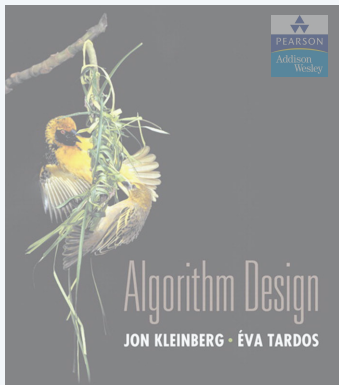

SECTION 6.4

6. DYNAMIC PROGRAMMING I

- ▶ *weighted interval scheduling*
- ▶ *segmented least squares*
- ▶ *knapsack problem*
- ▶ *RNA secondary structure*

Knapsack problem

Goal. Pack knapsack so as to maximize total value of items taken.

- There are n items: item i provides value $v_i > 0$ and weighs $w_i > 0$.
- Value of a subset of items = sum of values of individual items.
- Knapsack has weight limit of W .

Ex. The subset $\{1, 2, 5\}$ has value \$35 (and weight 10).

Ex. The subset $\{3, 4\}$ has value \$40 (and weight 11).

Assumption. All values and weights are integral.

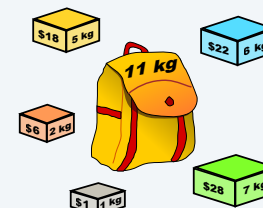

Creative Commons Attribution Share Alike 2.5 by Dake

i	v_i	w_i
1	\$1	1 kg
2	\$6	2 kg
3	\$18	5 kg
4	\$22	6 kg
5	\$28	7 kg

weights and values can be arbitrary positive integers

knapsack instance
(weight limit $W = 11$)

32

Dynamic programming: quiz 2



Which algorithm solves knapsack problem?

- A. Greedy-by-value: repeatedly add item with maximum v_i .
- B. Greedy-by-weight: repeatedly add item with minimum w_i .
- C. Greedy-by-ratio: repeatedly add item with maximum ratio v_i / w_i .
- D. None of the above.

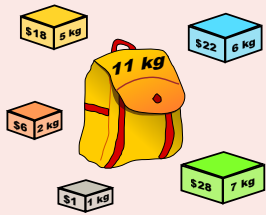

Creative Commons Attribution-Share Alike 2.5
by Dake

i	v_i	w_i
1	\$18	5 kg
2	\$6	2 kg
3	\$22	6 kg
4	\$22	6 kg
5	\$28	7 kg

knapsack instance
(weight limit $W = 11$)

33

Dynamic programming: quiz 3



Which subproblems?

- A. $OPT(w)$ = optimal value of knapsack problem with weight limit w .
- B. $OPT(i)$ = optimal value of knapsack problem with items $1, \dots, i$.
- C. $OPT(i, w)$ = optimal value of knapsack problem with items $1, \dots, i$ subject to weight limit w .
- D. Any of the above.

34

Dynamic programming: two variables

Def. $OPT(i, w)$ = optimal value of knapsack problem with items $1, \dots, i$, subject to weight limit w .

Goal. $OPT(n, W)$.

Case 1. $OPT(i, w)$ does not select item i .

- $OPT(i, w)$ selects best of $\{1, 2, \dots, i-1\}$ subject to weight limit w .

possibly because $w_i > w$

Case 2. $OPT(i, w)$ selects item i .

- Collect value v_i .
- New weight limit = $w - w_i$.
- $OPT(i, w)$ selects best of $\{1, 2, \dots, i-1\}$ subject to new weight limit.

optimal substructure property
(proof via exchange argument)

Bellman equation.

$$OPT(i, w) = \begin{cases} 0 & \text{if } i = 0 \\ OPT(i-1, w) & \text{if } w_i > w \\ \max \{ OPT(i-1, w), v_i + OPT(i-1, w - w_i) \} & \text{otherwise} \end{cases}$$

35

Knapsack problem: bottom-up dynamic programming

$KNAPSACK(n, W, w_1, \dots, w_n, v_1, \dots, v_n)$

FOR $w = 0$ TO W

$M[0, w] \leftarrow 0$.

FOR $i = 1$ TO n

FOR $w = 0$ TO W

IF $(w_i > w)$ $M[i, w] \leftarrow M[i-1, w]$.

ELSE $M[i, w] \leftarrow \max \{ M[i-1, w], v_i + M[i-1, w - w_i] \}$.

RETURN $M[n, W]$.

previously computed values

$$OPT(i, w) = \begin{cases} 0 & \text{if } i = 0 \\ OPT(i-1, w) & \text{if } w_i > w \\ \max \{ OPT(i-1, w), v_i + OPT(i-1, w - w_i) \} & \text{otherwise} \end{cases}$$

36

Knapsack problem: bottom-up dynamic programming demo

i	v_i	w_i
1	\$1	1 kg
2	\$6	2 kg
3	\$18	5 kg
4	\$22	6 kg
5	\$28	7 kg

$$OPT(i, w) = \begin{cases} 0 & \text{if } i = 0 \\ OPT(i-1, w) & \text{if } w_i > w \\ \max \{OPT(i-1, w), v_i + OPT(i-1, w - w_i)\} & \text{otherwise} \end{cases}$$

		weight limit w											
		0	1	2	3	4	5	6	7	8	9	10	11
subset of items $1, \dots, i$	{ }	0	0	0	0	0	0	0	0	0	0	0	0
	{ 1 }	0	1	1	1	1	1	1	1	1	1	1	1
	{ 1, 2 }	0	1	6	7	7	7	7	7	7	7	7	7
	{ 1, 2, 3 }	0	1	6	7	7	18	19	24	25	25	25	25
	{ 1, 2, 3, 4 }	0	1	6	7	7	18	22	24	28	29	29	40
	{ 1, 2, 3, 4, 5 }	0	1	6	7	7	18	22	28	29	34	35	40

$OPT(i, w)$ = optimal value of knapsack problem with items 1, ..., i, subject to weight limit w

37

Knapsack problem: running time

Theorem. The DP algorithm solves the knapsack problem with n items and maximum weight W in $\Theta(nW)$ time and $\Theta(nW)$ space.

Pf.

- Takes $O(1)$ time per table entry.
- There are $\Theta(nW)$ table entries.
- After computing optimal values, can trace back to find solution:
 $OPT(i, w)$ takes item i iff $M[i, w] > M[i-1, w]$. ■

weights are integers between 1 and W

Remarks.

- Algorithm depends critically on assumption that weights are integral.
- Assumption that values are integral was not used.

38

Dynamic programming: quiz 4



Does there exist a poly-time algorithm for the knapsack problem?

- Yes, because the DP algorithm takes $\Theta(nW)$ time.
- No, because $\Theta(nW)$ is not a polynomial function of the input size.
- No, because the problem is **NP**-hard.
- Unknown.

39

COIN CHANGING



Problem. Given n coin denominations $\{d_1, d_2, \dots, d_n\}$ and a target value V , find the fewest coins needed to make change for V (or report impossible).

Recall. Greedy cashier's algorithm is optimal for U.S. coin denominations, but not for arbitrary coin denominations.

Ex. $\{1, 10, 21, 34, 70, 100, 350, 1295, 1500\}$.

Optimal. $140\text{¢} = 70 + 70$.



40

COIN CHANGING



Def. $OPT(v) = \text{min number of coins to make change for } v.$

Goal. $OPT(V).$

Multiway choice. To compute $OPT(v),$

- Select a coin of denomination c_i for some $i.$
- Select fewest coins to make change for $v - c_i.$

optimal substructure property
(proof via exchange argument)

Bellman equation.

$$OPT(v) = \begin{cases} \infty & \text{if } v < 0 \\ 0 & \text{if } v = 0 \\ \min_{1 \leq i \leq n} \{ 1 + OPT(v - d_i) \} & \text{if } v > 0 \end{cases}$$

Running time. $O(nV).$

41

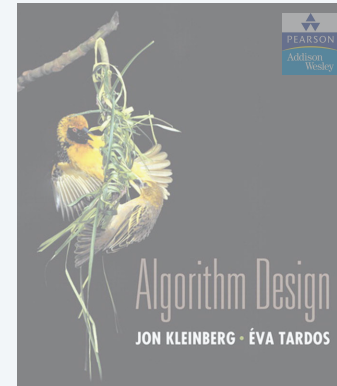

SECTION 6.5

6. DYNAMIC PROGRAMMING I

- ▶ *weighted interval scheduling*
- ▶ *segmented least squares*
- ▶ *knapsack problem*
- ▶ *RNA secondary structure*

RNA secondary structure

RNA. String $B = b_1 b_2 \dots b_n$ over alphabet $\{A, C, G, U\}.$

Secondary structure. RNA is single-stranded so it tends to loop back and form **base pairs** with itself. This structure is essential for understanding behavior of molecule.

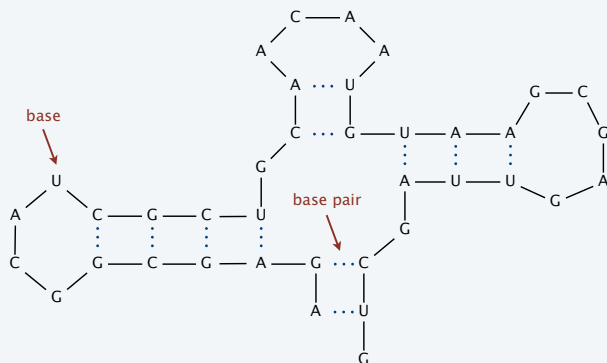

RNA secondary structure for GUCGAUUGAGCGAAUGUAACAACGUGGCUACGGCGAGA

43

RNA secondary structure

Secondary structure. A set of pairs $S = \{ (b_i, b_j) \}$ that satisfy:

- [Watson-Crick] S is a matching and each pair in S is a Watson-Crick complement: A-U, U-A, C-G, or G-C.

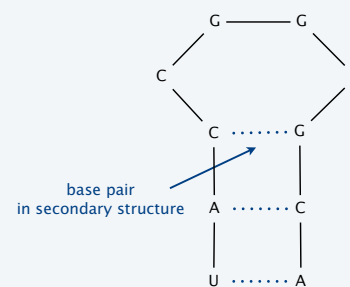

$B = \text{ACGUGGCCAU}$

$S = \{ (b_1, b_{10}), (b_2, b_9), (b_3, b_8) \}$

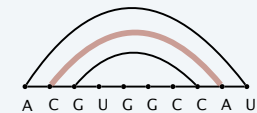

S is not a secondary structure
(C-A is not a valid Watson-Crick pair)

44

RNA secondary structure

Secondary structure. A set of pairs $S = \{ (b_i, b_j) \}$ that satisfy:

- [Watson-Crick] S is a matching and each pair in S is a Watson-Crick complement: A-U, U-A, C-G, or G-C.
- [No sharp turns] The ends of each pair are separated by at least 4 intervening bases. If $(b_i, b_j) \in S$, then $i < j - 4$.

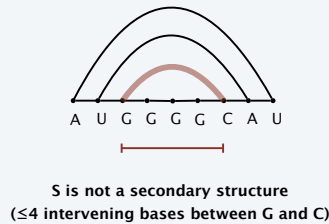
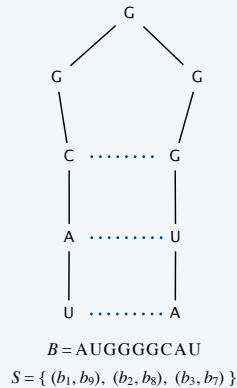

45

RNA secondary structure

Secondary structure. A set of pairs $S = \{ (b_i, b_j) \}$ that satisfy:

- [Watson-Crick] S is a matching and each pair in S is a Watson-Crick complement: A-U, U-A, C-G, or G-C.
- [No sharp turns] The ends of each pair are separated by at least 4 intervening bases. If $(b_i, b_j) \in S$, then $i < j - 4$.
- [Non-crossing] If (b_i, b_j) and (b_k, b_ℓ) are two pairs in S , then we cannot have $i < k < j < \ell$.

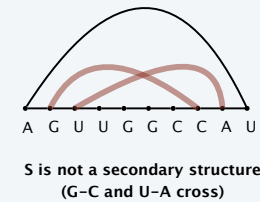
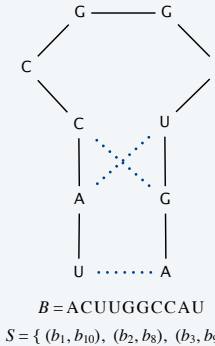

46

RNA secondary structure

Secondary structure. A set of pairs $S = \{ (b_i, b_j) \}$ that satisfy:

- [Watson-Crick] S is a matching and each pair in S is a Watson-Crick complement: A-U, U-A, C-G, or G-C.
- [No sharp turns] The ends of each pair are separated by at least 4 intervening bases. If $(b_i, b_j) \in S$, then $i < j - 4$.
- [Non-crossing] If (b_i, b_j) and (b_k, b_ℓ) are two pairs in S , then we cannot have $i < k < j < \ell$.

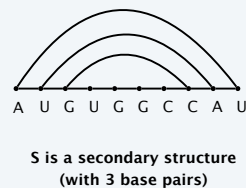
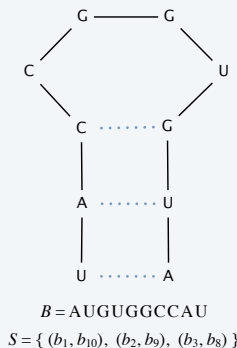

47

RNA secondary structure

Secondary structure. A set of pairs $S = \{ (b_i, b_j) \}$ that satisfy:

- [Watson-Crick] S is a matching and each pair in S is a Watson-Crick complement: A-U, U-A, C-G, or G-C.
- [No sharp turns] The ends of each pair are separated by at least 4 intervening bases. If $(b_i, b_j) \in S$, then $i < j - 4$.
- [Non-crossing] If (b_i, b_j) and (b_k, b_ℓ) are two pairs in S , then we cannot have $i < k < j < \ell$.

Free-energy hypothesis. RNA molecule will form the secondary structure with the minimum total free energy.

approximate by number of base pairs
 (more base pairs \Rightarrow lower free energy)

Goal. Given an RNA molecule $B = b_1 b_2 \dots b_n$, find a secondary structure S that maximizes the number of base pairs.

48



Is the following a secondary structure?

- A. Yes.
- B. No, violates Watson-Crick condition.
- C. No, violates no-sharp-turns condition.
- D. No, violates no-crossing condition.

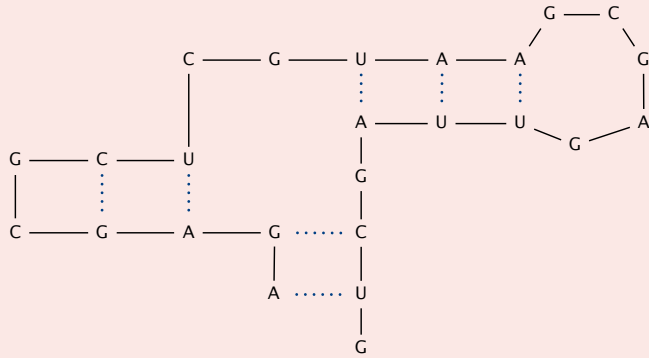

Which subproblems?

- A. $OPT(j) = \max$ number of base pairs in secondary structure of the substring $b_1b_2 \dots b_j$.
- B. $OPT(j) = \max$ number of base pairs in secondary structure of the substring $b_jb_{j+1} \dots b_n$.
- C. Either A or B.
- D. Neither A nor B.

RNA secondary structure: subproblems

First attempt. $OPT(j) = \max$ imum number of base pairs in a secondary structure of the substring $b_1b_2 \dots b_j$.

Goal. $OPT(n)$.

Choice. Match bases b_t and b_j .

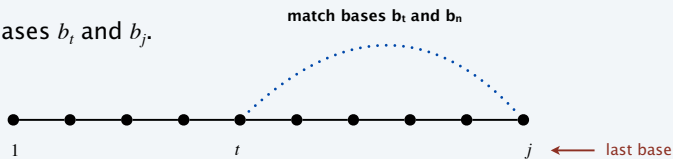

Difficulty. Results in two subproblems (but one of wrong form).

- Find secondary structure in $b_1b_2 \dots b_{t-1}$. ← $OPT(t-1)$
- Find secondary structure in $b_{t+1}b_{t+2} \dots b_{j-1}$. ← need more subproblems (first base no longer b_t)

Dynamic programming over intervals

Def. $OPT(i, j) = \max$ imum number of base pairs in a secondary structure of the substring $b_ib_{i+1} \dots b_j$.

Case 1. If $i \geq j - 4$.

- $OPT(i, j) = 0$ by no-sharp-turns condition.

Case 2. Base b_j is not involved in a pair.

- $OPT(i, j) = OPT(i, j - 1)$.

Case 3. Base b_j pairs with b_t for some $i \leq t < j - 4$.

- Non-crossing condition decouples resulting two subproblems.
- $OPT(i, j) = 1 + \max_t \{ OPT(i, t - 1) + OPT(t + 1, j - 1) \}$.

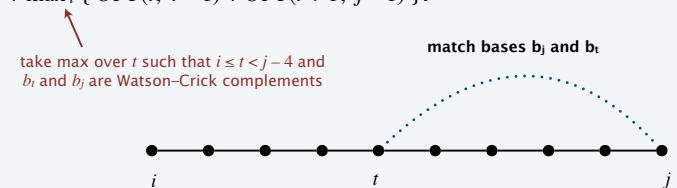



In which order to compute $OPT(i, j)$?

- A. Increasing i , then j .
- B. Increasing j , then i .
- C. Either A or B.
- D. Neither A nor B.

- Q. In which order to solve the subproblems?
 A. Do shortest intervals first—increasing order of $|j - i|$.

```

RNA-SECONDARY-STRUCTURE( $n, b_1, \dots, b_n$ )
FOR  $k = 5$  TO  $n - 1$ 
  FOR  $i = 1$  TO  $n - k$ 
     $j \leftarrow i + k$ .
    Compute  $M[i, j]$  using formula.
RETURN  $M[1, n]$ .
    
```

all needed values are already computed

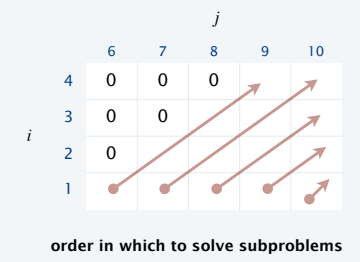

Theorem. The DP algorithm solves the RNA secondary structure problem in $O(n^3)$ time and $O(n^2)$ space.

Dynamic programming summary

Outline.

- Define a collection of subproblems.
- Solution to original problem can be computed from subproblems.
- Natural ordering of subproblems from “smallest” to “largest” that enables determining a solution to a subproblem from solutions to smaller subproblems.

typically, only a polynomial number of subproblems

Techniques.

- Binary choice: weighted interval scheduling.
- Multiway choice: segmented least squares.
- Adding a new variable: knapsack problem.
- Intervals: RNA secondary structure.

Top-down vs. bottom-up dynamic programming. Opinions differ.