



I/O Management

Goals of this Lecture



Help you to learn about:

- The C/Unix **file** abstraction
- Standard C I/O
 - Data structures & functions
- Unix I/O
 - Data structures & functions
- The implementation of Standard C I/O using Unix I/O
- Programmatic redirection of stdin, stdout, and stderr
- Pipes

Agenda



The C/Unix file abstraction

Unix I/O system calls

C's Standard IO library (FILE *)

Implementing standard C I/O using Unix I/O

(next time) Redirecting standard files

(next time) Pipes

C/Unix File Abstraction



Problem:

- At the physical level...
- Code that **reads** from **keyboard** is very different from code that reads from **disk**, etc.
- Code that **writes** to **video screen** is very different from code that writes to **disk**, etc.
- Would be nice if application programmer didn't need to worry about such details

Solution:

- **File**: a sequence of bytes
- C and Unix allow application program to treat any data source/destination as a **file**

Commentary: **Beautiful** abstraction!

Data Sources and Destinations

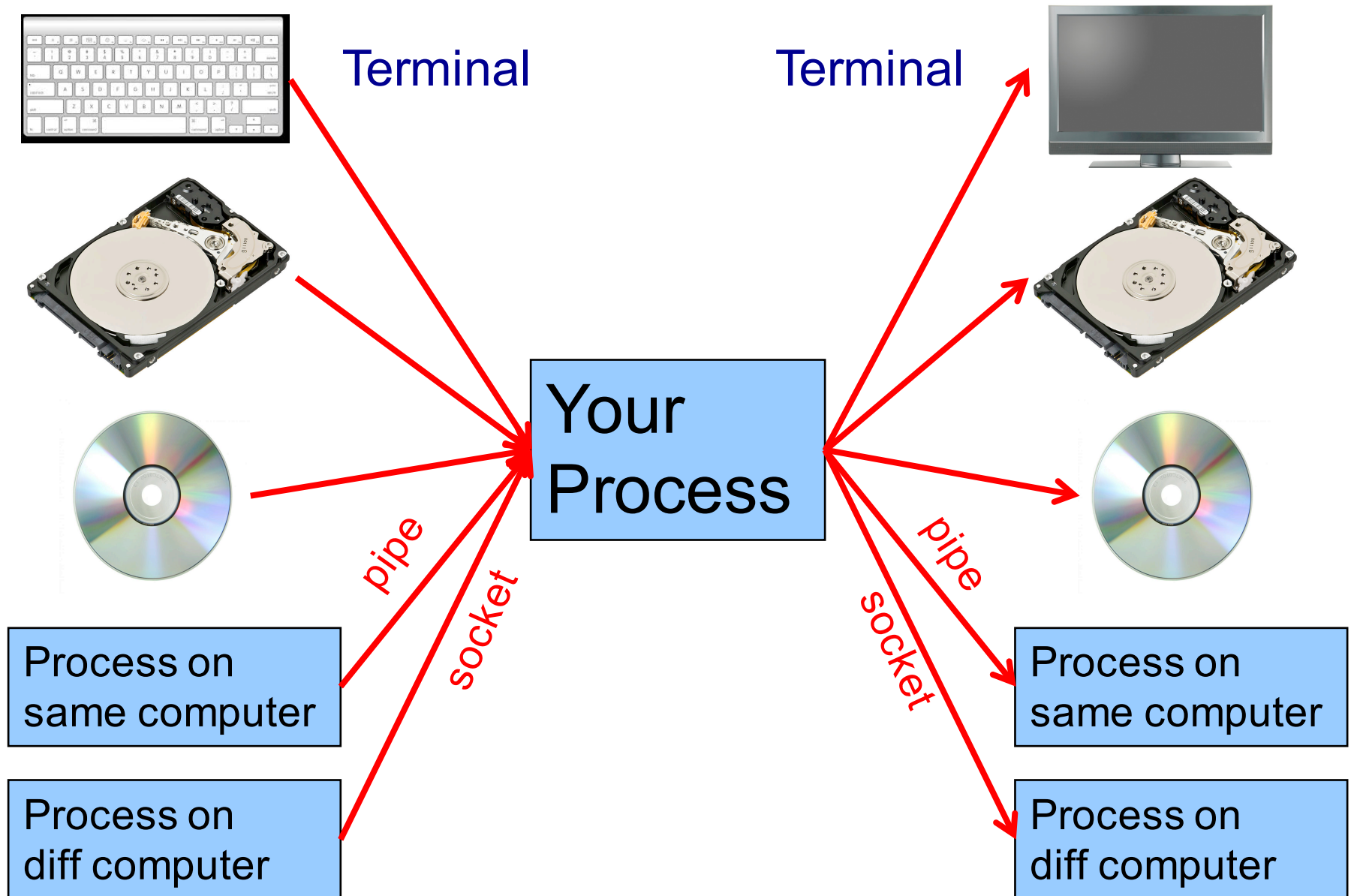

C/Unix File Abstraction



Each file has an associated **file position**

- Starts at beginning of file (if opened to read or write)
- Starts at end of file (if opened to append)

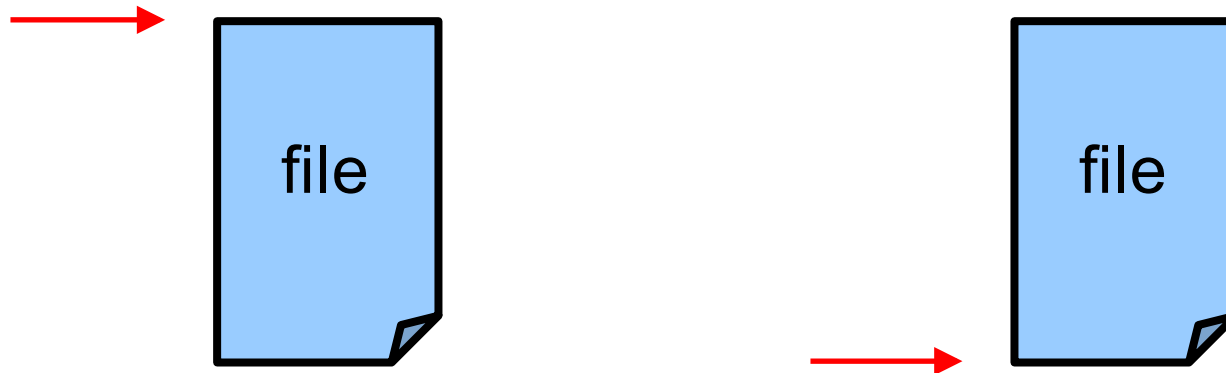

Agenda



The C/Unix file abstraction

Unix I/O system calls

C's Standard IO library (FILE *)

Implementing standard C I/O using Unix I/O

(next time) Redirecting standard files

(next time) Pipes

System-Level Functions Covered



As noted in the *Exceptions and Processes* lecture...

Linux system-level functions for **I/O management**

Number	Function	Description
0	read()	Read data from file descriptor Called by getchar(), scanf(), etc.
1	write()	Write data to file descriptor Called by putchar(), printf(), etc.
2	open()	Open file or device Called by fopen(..., "r")
3	close()	Close file descriptor Called by fclose()
85	creat()	Open file or device for writing Called by fopen(..., "w")
8	lseek()	Change file position Called by fseek()

System-Level Functions



As noted in the *Exceptions and Processes* lecture..

Linux system-level functions for **I/O redirection** and **inter-process communication**

Number	Function	Description
32	dup()	Duplicate an open file descriptor
22	pipe()	Create a channel of communication between processes

Unix I/O Data Structures

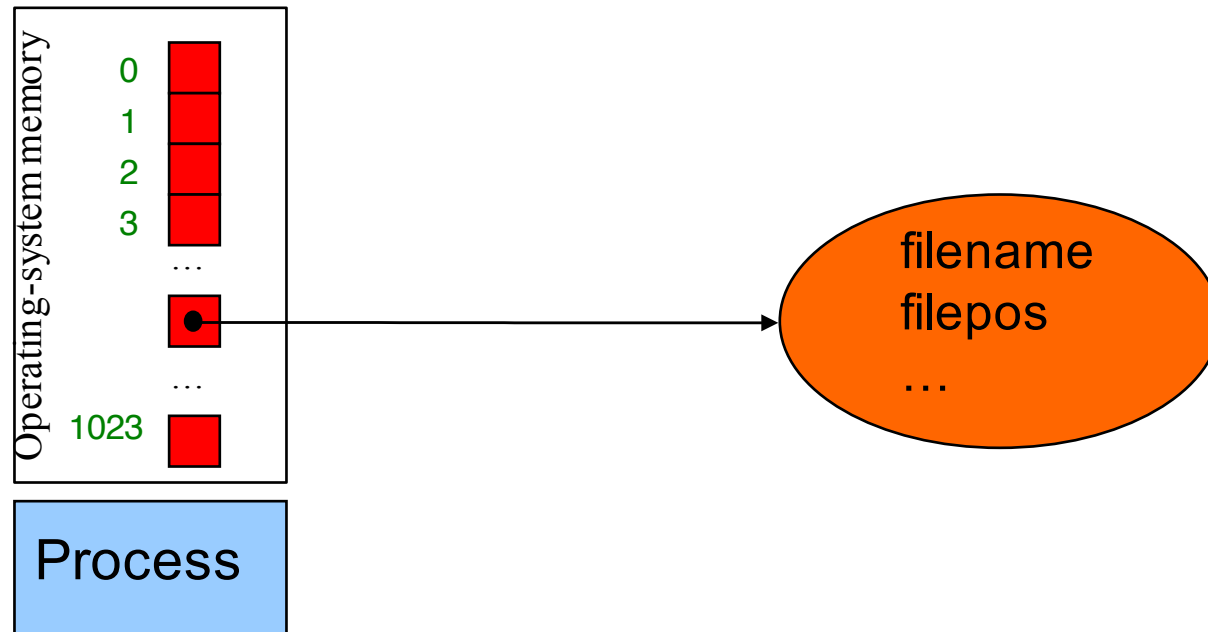

File descriptor: Integer that uniquely identifies an open file

File descriptor table: an array

Indices are file descriptors; elements are pointers to file tables

One unique file descriptor table for each process

File table: a structure

In-memory surrogate for an open file

Created when process opens file; maintains file position

Unix I/O Data Structures

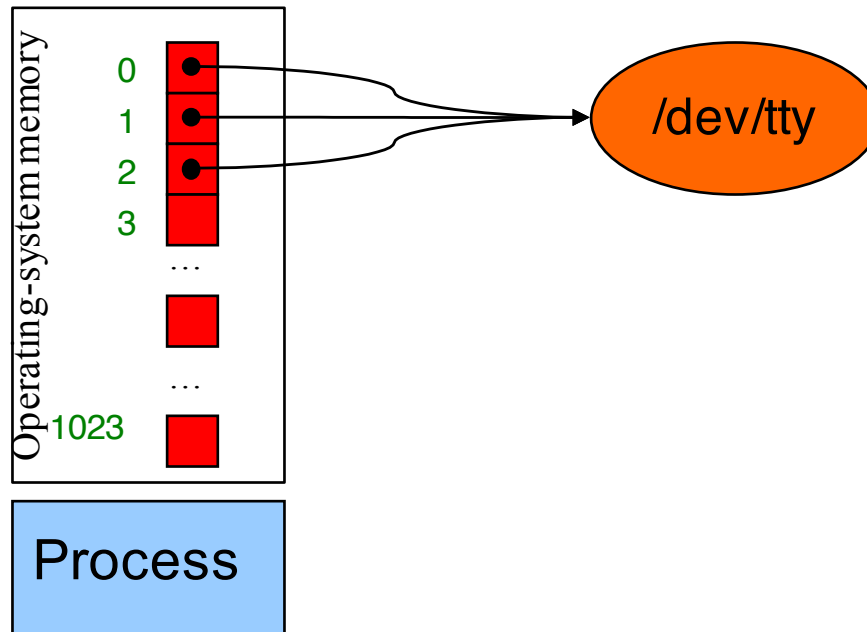

At process start-up files with fd 0, 1, 2 are open automatically
(By default) each references file table for a file named /dev/tty

/dev/tty

In-memory surrogate for the terminal

Terminal

Combination keyboard/video screen

Unix I/O Data Structures

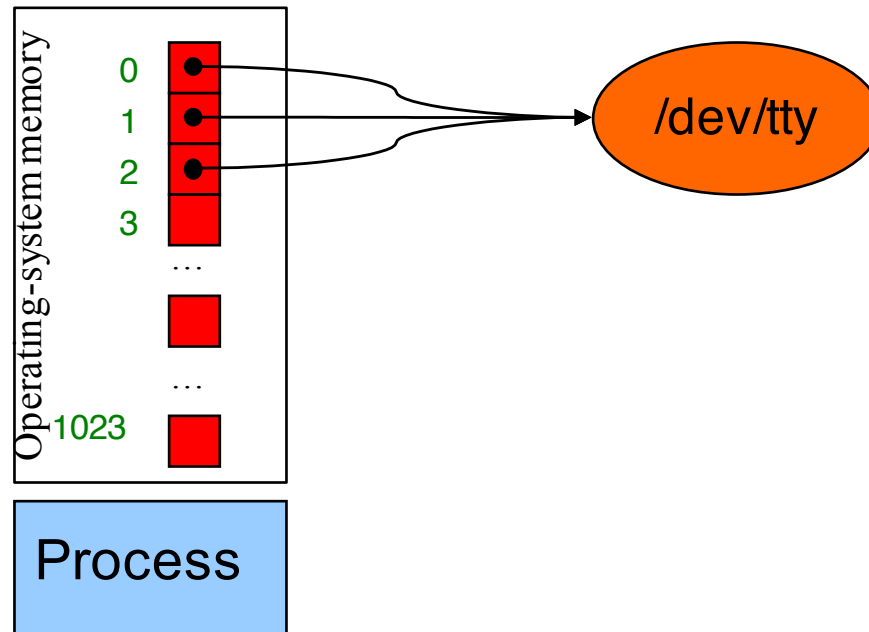

Read from stdin \Rightarrow read from fd 0

Write to stdout \Rightarrow write to fd 1

Write to stderr \Rightarrow write to fd 2

Unix I/O Functions



```
int creat(char *filename, mode_t mode);
```

- Create a new empty file named `filename`
 - `mode` indicates permissions of new file
- Implementation:
 - Create new empty file on disk
 - Create file table
 - Set first unused file descriptor to point to file table
 - Return file descriptor used, -1 upon failure

Unix I/O Functions



```
int open(char *filename, int flags, ...);
```

- Open the file whose name is `filename`
 - `flags` often is `O_RDONLY`
- Implementation (assuming `O_RDONLY`):
 - Find existing file on disk
 - Create file table
 - Set first unused file descriptor to point to file table
 - Return file descriptor used, -1 upon failure

Unix I/O Functions



```
int close(int fd);
```

- Close the file `fd`
- Implementation:
 - Destroy file table referenced by element `fd` of file descriptor table
 - As long as no other process is pointing to it!
 - Set element `fd` of file descriptor table to **NULL**

Unix I/O Functions



```
int read(int fd, void *buf, int count);
```

- Read into `buf` up to `count` bytes from file `fd`
- Return the number of bytes read; 0 indicates end-of-file

```
int write(int fd, void *buf, int count);
```

- Writes up to `count` bytes from `buf` to file `fd`
- Return the number of bytes written; -1 indicates error

```
int lseek(int fd, int offset, int whence);
```

- Set the file position of file `fd` to file position `offset`. `whence` indicates if the file position is measured from the beginning of the file (`SEEK_SET`), from the current file position (`SEEK_CUR`), or from the end of the file (`SEEK_END`)
- Return the file position from the beginning of the file

Unix I/O Functions



Note

- Only 6 system-level functions support all I/O from all kinds of devices!

Commentary: **Beautiful** interface!

Unix I/O Example 0



Proto-getchar()

```
#include <string.h>
#include <unistd.h>

int proto_getchar(void)
{ char buf[1];
  int n;

  n = read(0, buf, 1);
  if (n==1)
    return buf[0];
  else return EOF;
}
```

of bytes to (try to) read

0 is the file descriptor of the standard input

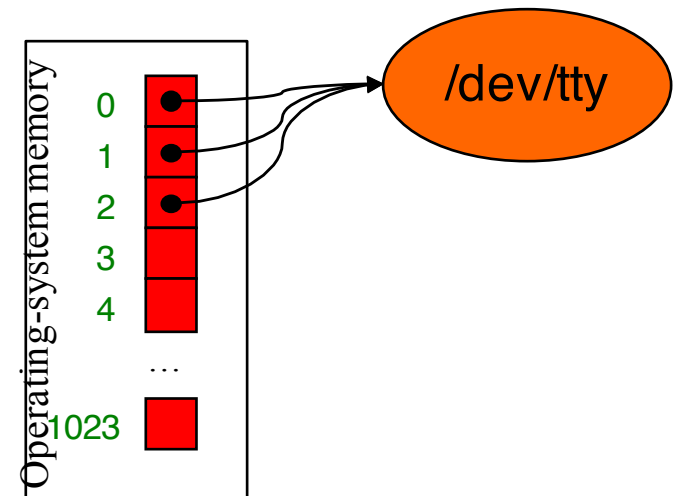

and the problem is . . . too slow.

Does a system call for every character.

Unix I/O Example 1



Write “hello, world\n” to /dev/tty

```
#include <string.h>
#include <unistd.h>
int main(void)
{ char hi[] = "hello, world\n";
  size_t countWritten = 0;
  size_t countToWrite = strlen(hi);
  while (countWritten < countToWrite)
    countWritten +=
      write(1, hi + countWritten,
           countToWrite - countWritten);
  return 0;
}
```

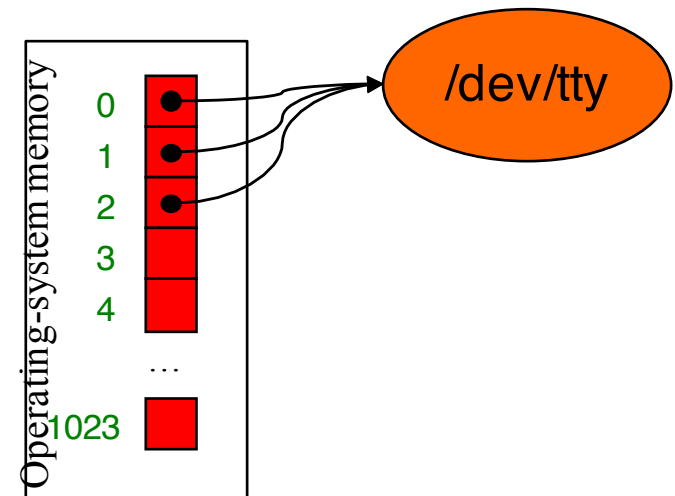

To save space,
no error handling
code is shown

Unix I/O Example 2



```
#include <fcntl.h>
#include <unistd.h>
int main(void)
{  enum {BUFFERSIZE = 10};
   int fdIn, fdOut;
   int countRead, countWritten;
   char buf[BUFFERSIZE];
   fdIn = open("infile", O_RDONLY);
   fdOut = creat("outfile", 0600);
   for (;;)
   {  countRead =
      read(fdIn, buf, BUFFERSIZE);
      if (countRead == 0) break;
      countWritten = 0;
      while (countWritten < countRead)
        countWritten +=
          write(fdOut,
              buf + countWritten,
              countRead - countWritten);
   }
   close(fdOut);
   close(fdIn);
   return 0;
}
```

Copy all bytes
from infile to outfile

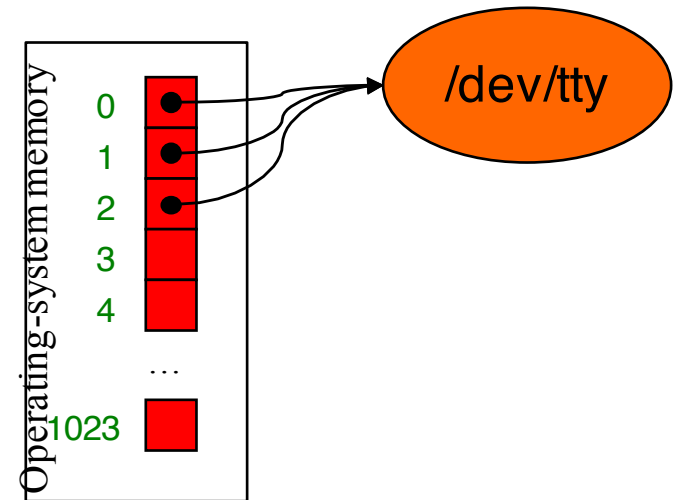

To save space,
no error handling
code is shown

Unix I/O Example 2



```
#include <fcntl.h>
#include <unistd.h>
int main(void)
{  enum {BUFFERSIZE = 10};          3
   int fdIn, fdOut;
   int countRead, countWritten;
   char buf[BUFFERSIZE];
   fdIn ← open("infile", O_RDONLY);
   fdOut = creat("outfile", 0600);
   for (;;)
   {  countRead =
       read(fdIn, buf, BUFFERSIZE);
       if (countRead == 0) break;
       countWritten = 0;
       while (countWritten < countRead)
           countWritten +=
               write(fdOut,
                    buf + countWritten,
                    countRead - countWritten);
   }
   close(fdOut);
   close(fdIn);
   return 0;
}
```

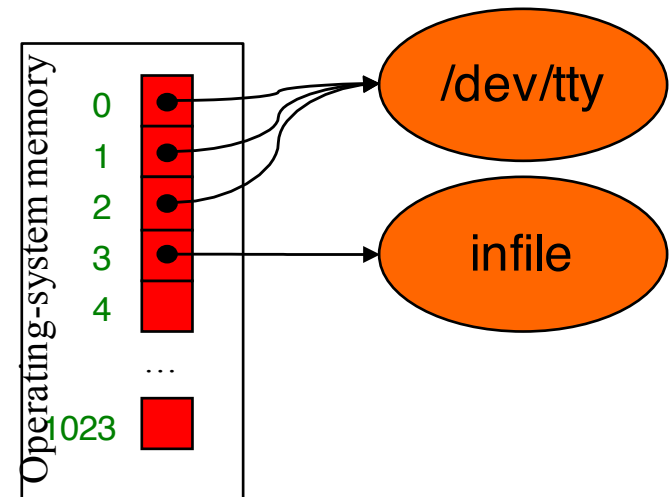

Unix I/O Example 2



```
#include <fcntl.h>
#include <unistd.h>
int main(void)
{  enum {BUFFERSIZE = 10};          3
   int fdIn, fdOut;
   int countRead, countWritten;    4
   char buf[BUFFERSIZE];
   fdIn ← open("infile", O_RDONLY);
   fdOut ← creat("outfile", 0600);
   for (;;)
   {  countRead =
       read(fdIn, buf, BUFFERSIZE);
       if (countRead == 0) break;
       countWritten = 0;
       while (countWritten < countRead)
           countWritten +=
               write(fdOut,
                    buf + countWritten,
                    countRead - countWritten);
   }
   close(fdOut);
   close(fdIn);
   return 0;
}
```

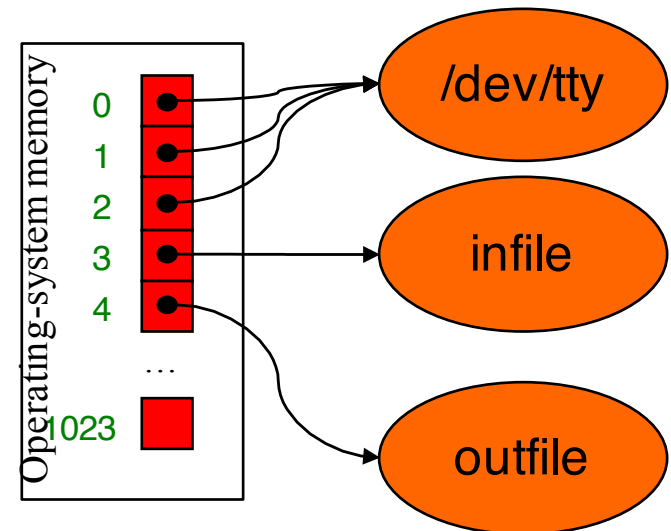

Unix I/O Example 2



```
#include <fcntl.h>
#include <unistd.h>
int main(void)
{
  enum {BUFFERSIZE = 10};
  int fdIn, fdOut;
  int countRead, countWritten;
  char buf[BUFFERSIZE];
  fdIn ← open("infile", O_RDONLY);
  fdOut ← creat("outfile", 0600);
  for (;;)
  {
    countRead =
      read(fdIn, buf, BUFFERSIZE);
    if (countRead == 0) break;
    countWritten = 0;
    while (countWritten < countRead)
      countWritten +=
        write(fdOut,
              buf + countWritten,
              countRead - countWritten);
  }
  close(fdOut);
  close(fdIn);
  return 0;
}
```

3

4

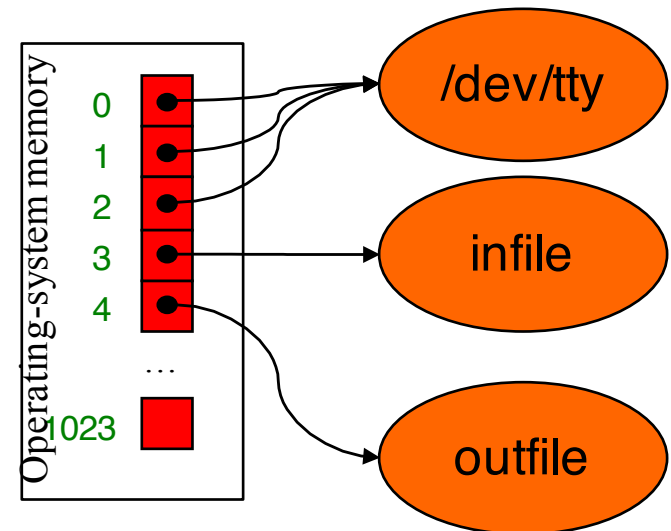

Unix I/O Example 2



```
#include <fcntl.h>
#include <unistd.h>
int main(void)
{
  enum {BUFFERSIZE = 10};
  int fdIn, fdOut;
  int countRead, countWritten;
  char buf[BUFFERSIZE];
  fdIn ← open("infile", O_RDONLY);
  fdOut ← creat("outfile", 0600);
  for (;;)
  {
    countRead =
      read(fdIn, buf, BUFFERSIZE);
    if (countRead == 0) break;
    countWritten = 0;
    while (countWritten < countRead)
      countWritten +=
        write(fdOut,
              buf + countWritten,
              countRead - countWritten);
  }
  close(fdOut);
  close(fdIn);
  return 0;
}
```

3

4

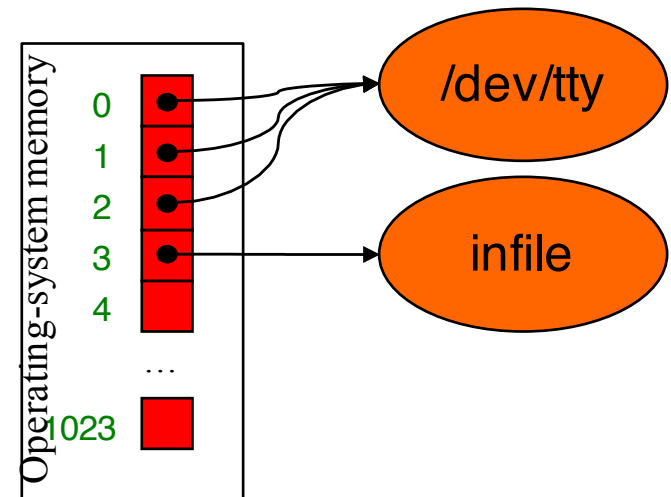

Unix I/O Example 2



```
#include <fcntl.h>
#include <unistd.h>
int main(void)
{
  enum {BUFFERSIZE = 10};           3
  int fdIn, fdOut;
  int countRead, countWritten;     4
  char buf[BUFFERSIZE];
  fdIn ← open("infile", O_RDONLY);
  fdOut ← creat("outfile", 0600);
  for (;;)
  {
    countRead =
      read(fdIn, buf, BUFFERSIZE);
    if (countRead == 0) break;
    countWritten = 0;
    while (countWritten < countRead)
      countWritten +=
        write(fdOut,
              buf + countWritten,
              countRead - countWritten);
  }
  close(fdOut);
  close(fdIn);
  return 0;
}
```

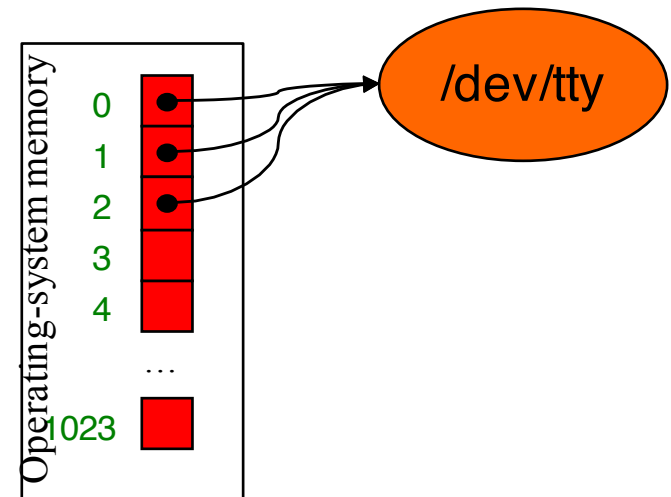

Agenda



The C/Unix file abstraction

Unix I/O system calls

C's Standard IO library (FILE *)

Implementing standard C I/O using Unix I/O

(next time) Redirecting standard files

(next time) Pipes

Standard C I/O Data Structure



We want 1-character-at-a-time I/O (`getc()`, `putc()`)

We want a-few-characters-at-a-time I/O (`scanf`, `printf`)

We *could* do this with `read()` and `write()` system calls,

BUT IT WOULD BE TOO SLOW to do 1 syscall per byte

Solution: Buffered input/output as an Abstract Data Type

The **FILE** ADT

- A **FILE** object is an in-memory surrogate for an opened file
 - Created by `fopen()`
 - Destroyed by `fclose()`
- Used by reading/writing functions

Standard C I/O Functions



Some of the most popular:

```
FILE *fopen(const char *filename, const char *mode) ;
```

- Open the file named **filename** for reading or writing
- **mode** indicates data flow direction
 - “r” means read; “w” means write, “a” means append)
- Creates **FILE** structure
- Returns address of **FILE** structure

```
int fclose(FILE *file) ;
```

- Close the file identified by **file**
- Destroys **FILE** structure whose address is **file**
- Returns 0 on success, EOF on failure

Standard C Input Functions



Some of the most popular:

```
int fgetc(FILE *file);
```

- Read a char from the file identified by **file**
- Return the char on success, **EOF** on failure

```
int getchar(void);
```

- Same as **fgetc(stdin)**

```
char *fgets(char *s, int n, FILE *file);
```

- Read at most **n** characters from **file** into array **s**
- Returns **s** on success, **NULL** on failure

```
char *gets(char *s);
```

- Essentially same as **fgets(s, INT_MAX, stdin)**
- *Using “gets” counts as Moral Turpitude for software engineers*

Standard C Input Functions



Some of the most popular:

```
int fscanf(FILE *file, const char *format, ...);
```

- Read chars from the file identified by **file**
- Convert to values, as directed by **format**
- Copy values to memory
- Return count of values successfully scanned

```
int scanf(const char *format, ...);
```

- Same as **fscanf(stdin, format, ...)**

Standard C Output Functions



Some of the most popular:

```
int fputc(int c, FILE *file);
```

- Write `c` (converted to a char) to file
- Return `c` on success, `EOF` on failure

```
int putchar(int c);
```

- Same as `fputc(c, stdout)`

```
int fputs(const char *s, FILE *file);
```

- Write string `s` to `file`
- Return non-negative on success, `EOF` on error

```
int puts(const char *s);
```

- Essentially same as `fputs(s, stdout)`

Standard C Output Functions



Some of the most popular:

```
int fprintf(FILE *file, const char *format, ...);
```

- Write chars to the file identified by `file`
- Convert values to chars, as directed by `format`
- Return count of chars successfully written
- Works by calling `fputc()` repeatedly

```
int printf(const char *format, ...);
```

- Same as `fprintf(stdout, format, ...)`

Standard C I/O Functions



Some of the most popular:

```
int fflush(FILE *file);
```

- On an output file: write any buffered chars to **file**
- On an input file: behavior undefined
- **file == NULL** \Rightarrow flush buffers of **all** open files

```
int fseek(FILE *file, long offset, int origin);
```

- Set the file position of **file**
- Subsequent read/write accesses data starting at that position
- Origin: **SEEK_SET, SEEK_CUR, SEEK_END**

```
int ftell(FILE *file);
```

- Return file position of **file** on success, -1 on error

Standard C I/O Example 1



Write “hello, world\n” to stdout

```
#include <stdio.h>
int main(void)
{ char hi[] = "hello world\n";
  size_t i = 0;
  while (hi[i] != '\0')
  { putchar(hi[i]);
    i++;
  }
  return 0;
}
```

Simple
Portable
Efficient (via buffering)

```
#include <stdio.h>
int main(void)
{ puts("hello, world");
  return 0;
}
```

```
#include <stdio.h>
int main(void)
{ printf("hello, world\n");
  return 0;
}
```

Standard C I/O Example 2



Copy all bytes from infile to outfile

```
#include <stdio.h>
int main(void)
{  int c;
   FILE *infile;
   FILE *outfile;
   infile = fopen("infile", "r");
   outfile = fopen("outfile", "w");
   while ((c = fgetc(infile)) != EOF)
       fputc(c, outfile);
   fclose(outfile);
   fclose(infile);
   return 0;
}
```

Simple
Portable
Efficient (via buffering)

Standard C Buffering



Question: Exactly when are buffers flushed?

Answers:

If reading from a file

(1) When buffer is empty

Standard C Buffering



Question: Exactly when are buffers flushed?

Answers:

If writing to an ordinary file

- (1) File's buffer becomes full
- (2) Process calls `fflush()` on that file
- (3) Process terminates normally

If writing to `stdout` (in addition to previous)

- (4) `stdout` is bound to terminal and `'\n'` is appended to buffer
- (5) `stdin` and `stdout` are bound to terminal
and read from `stdin` occurs

If writing to `stderr`

- Irrelevant; `stderr` is unbuffered

Standard C Buffering Example



```
#include <stdio.h>
int main(void)
{ int dividend, divisor, quotient;

  printf("Dividend: ");
  scanf("%d", &dividend);

  printf("Divisor: ");
  scanf("%d", &divisor);

  printf("The quotient is ");
  quotient = dividend / divisor;
  printf("%d\n", quotient);
  return 0;
}
```

Output buffered
Buffer flushed

Output buffered
Buffer flushed

Output buffered
Buffer flushed

```
$ pgm
Dividend: 6
Divisor: 2
The quotient is 3
$
```

```
$ pgm
Dividend: 6
Divisor: 0
Floating point exception
$
```

Agenda



The C/Unix file abstraction

Unix I/O system calls

C's Standard IO library (FILE *)

Implementing standard C I/O using Unix I/O

(next time) Redirecting standard files

(next time) Pipes

Standard C I/O



Question:

- How to implement standard C I/O data structure and functions using Unix I/O data structures and functions?

Answer:

- In principle...
- In stages...

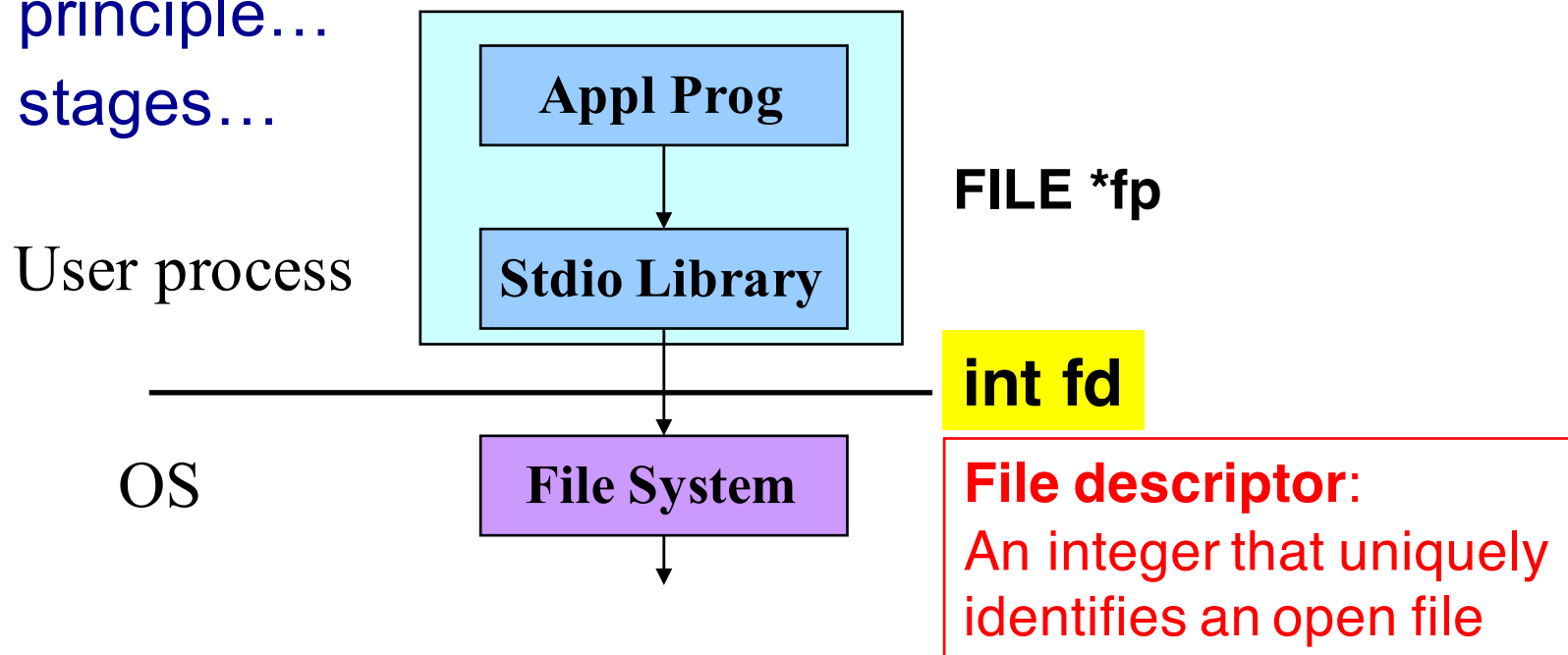

Implementing getchar and putchar



`getchar()` calls `read()` to read one byte from fd 0

`putchar()` calls `write()` to write one byte to fd 1

```
int getchar(void)
{ unsigned char c;
  if (read(0, &c, 1) == 1)
    return (int)c;
  else
    return EOF;
}
```

```
int putchar(int c)
{ if (write(1, &c, 1) == 1)
  return c;
  else
    return EOF;
}
```

Implementing Buffering



Problem: poor performance

- `read()` and `write()` access a physical device (e.g., a disk)
- Reading/writing one char at a time can be time consuming
- Better to read and write in larger blocks
 - Recall ***Storage Management*** lecture

Solution: buffered I/O

- **Read** a large block of chars from source device into a buffer
 - Provide chars from buffer to the client as needed
- **Write** individual chars to a buffer
 - “Flush” buffer contents to destination device when buffer is full, or when file is closed, or upon client request

Implementing getchar Version 2



`getchar()` calls `read()` to read multiple chars from fd 0 into buffer

```
int getchar(void)
{
    enum {BUFFERSIZE = 4096}; /*arbitrary*/
    static unsigned char buffer[BUFFERSIZE];
    static unsigned char *bufferPtr;
    static int bufferCount = 0;
    if (bufferCount == 0) /* must read */
    {
        bufferCount =
            read(0, buffer, BUFFERSIZE);
        if (bufferCount <= 0) return EOF;
        bufferPtr = buffer;
    }
    bufferCount--;
    bufferPtr++;
    return (int) (* (bufferPtr-1));
}
```

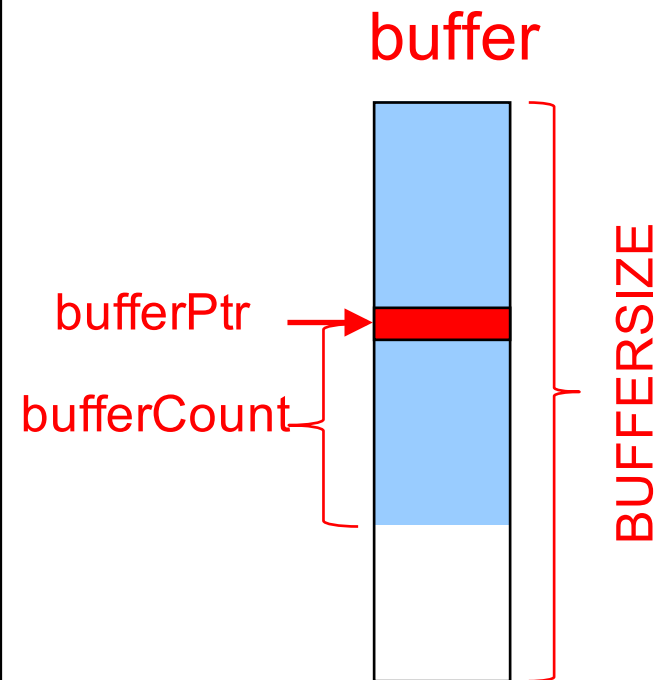

Implementing putchar Version 2



`putchar()` calls `write()` to write multiple chars from buffer to fd 1

```
int putchar(int c)
{
    enum {BUFFERSIZE = 4096};
    static char buffer[BUFFERSIZE];
    static int bufferCount = 0;
    if (bufferCount == BUFFERSIZE) /* must write */
    {
        int countWritten = 0;
        while (countWritten < bufferCount)
        {
            int count =
                write(1, buffer+countWritten, BUFFERSIZE-countWritten);
            if (count <= 0) return EOF;
            countWritten += count;
        }
        bufferCount = 0;
    }
    buffer[bufferCount] = (char)c;
    bufferCount++;
    return c;
}
```

Real implementation
also flushes buffer
at other times

Implementing the `FILE` ADT



Observation:

- `getchar ()` reads from `stdin` (fd 0)
- `putchar ()` writes to `stdout` (fd 1)

Problem:

- How to read/write from/to files other than `stdin` (fd 0) and `stdout` (fd 1)?
- Example: How to define `fgetc ()` and `fputc ()`?

Solution:

- Use `FILE` structure

Implementing the FILE ADT



```
enum {BUFFERSIZE = 4096};

struct File
{  unsigned char  buffer[BUFFERSIZE]; /* buffer */
   int           bufferCount; /* num chars left in buffer */
   unsigned char *bufferPtr; /* ptr to next char in buffer */
   int           flags; /* open mode flags, etc. */
   int           fd; /* file descriptor */
};

typedef struct File FILE;

/* Initialize standard files. */
FILE *stdin = ...
FILE *stdout = ...
FILE *stderr = ...
```

Derived from
K&R Section 8.5

More complex
on our system

Implementing `fopen` and `fclose`



```
f = fopen(filename, "r")
```

- Create new `FILE` structure; set `f` to point to it
- Initialize all fields
- `f->fd = open(filename, ...)`
- Return `f`

```
f = fopen(filename, "w")
```

- Create new `FILE` structure; set `f` to point to it
- Initialize all fields
- `f->fd = creat(filename, ...)`
- Return `f`

```
fclose(f)
```

- `close(f->fd)`
- Destroy `FILE` structure

Implementing fgetc



```
int fgetc(FILE *f)
{
    if (f->bufferCount == 0) /* must read */
    {
        f->bufferCount =
            read(f->fd, f->buffer, BUFFERSIZE);
        if (f->bufferCount <= 0) return EOF;
        f->bufferPtr = f->buffer;
    }
    f->bufferCount--;
    f->bufferPtr++;
    return (int) (*(f->bufferPtr-1));
}
```

- Accepts FILE pointer f as parameter
- Uses fields within f
- Reads from f->fd instead of 0

Implementing fputc



```
int fputc(int c, FILE *f)
{  if (f->bufferCount == BUFFERSIZE) /* must write */
    {  int countWritten = 0;
        while (countWritten < f->bufferCount)
            {  int count =
                write(f->fd, f->buffer+countWritten,
                    BUFFERSIZE-countWritten);
                if (count <= 0) return EOF;
                countWritten += count;
            }
        f->bufferCount = 0;
    }
    f->buffer[f->bufferCount] = (char)c;
    f->bufferCount++;
    return c;
}
```

Real implementation
also flushes buffer
at other times

- Accepts FILE pointer f as parameter
- Uses fields within f
- Writes to f->fd instead of 1

Implementing Standard C I/O Functions



Standard C Function	In Unix Implemented by Calling
fopen()	open() or creat()
fclose()	close()

Implementing Standard C I/O Functions



Standard C Function	In Unix Implemented by Calling
fgetc()	read()
getchar()	fgetc()
fgets()	fgetc()
gets()	fgets()
fscanf()	fgetc()
scanf()	fscanf()

Implementing Standard C I/O Functions



Standard C Function	In Unix Implemented by Calling
fputc()	write()
putchar()	fputc()
fputs()	fputc()
puts()	fputs()
fprintf()	fputc()
printf()	fprintf()

Implementing Standard C I/O Functions



Standard C Function	In Unix Implemented by Calling
<code>fflush()</code>	
<code>fseek()</code>	<code>lseek()</code>
<code>ftell()</code>	<code>lseek()</code>

Agenda



The C/Unix file abstraction

Unix I/O system calls

C's Standard IO library (FILE *)

Implementing standard C I/O using Unix I/O

(next time) Redirecting standard files

(next time) Pipes

Redirection



Unix allows programmatic redirection of **stdin**, **stdout**, or **stderr**

How?

- Use `open()`, `creat()`, and `close()` system-level functions
- Use `dup()` system-level function

`int dup(int oldfd);`

- Create a copy of file descriptor `oldfd`
- Old and new file descriptors may be used interchangeably; they refer to the same open file table and thus share file position and file status flags
- Uses the lowest-numbered unused descriptor for the new descriptor
- Returns the new descriptor, or -1 if an error occurred.

Redirection Example



How does shell implement `somepgm > somefile`?

```
pid = fork();
if (pid == 0)
{ /* in child */
  fd = creat("somefile", 0600);
  close(1);
  dup(fd);
  close(fd);
  execvp(somepgm, someargv);
  fprintf(stderr, "exec failed\n");
  exit(EXIT_FAILURE);
}
/* in parent */
wait(NULL);
```

Redirection Example Trace (1)



Parent Process

File
descriptor
table

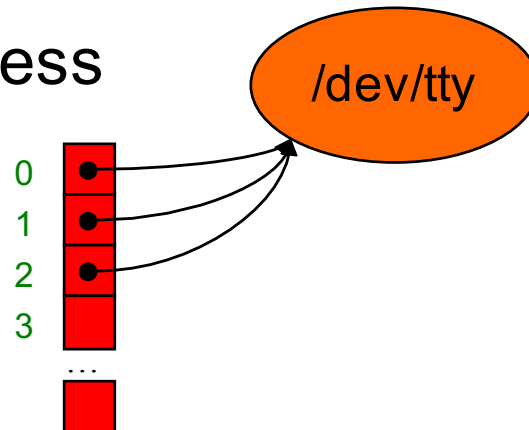

```
pid = fork();
if (pid == 0)
{ /* in child */
  fd = creat("somefile", 0600);
  close(1);
  dup(fd);
  close(fd);
  execvp(somepgm, someargv);
  fprintf(stderr, "exec failed\n");
  exit(EXIT_FAILURE);
}
/* in parent */
wait(NULL);
```

Parent has file descriptor table; first three point to “terminal”

Redirection Example Trace (2)

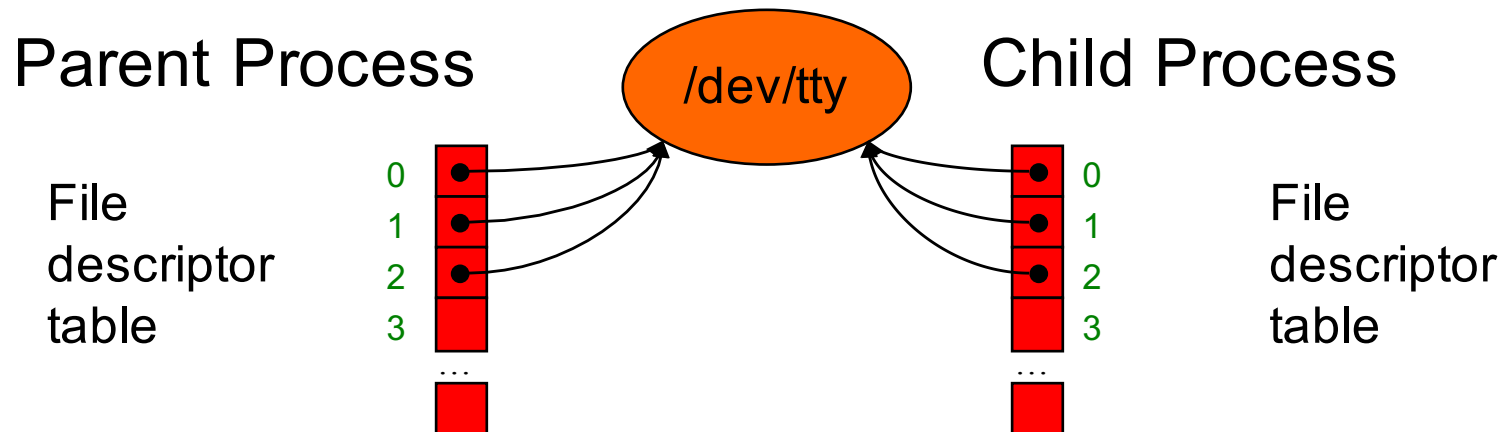

```
pid = fork();
if (pid == 0)
{ /* in child */
  fd = creat("somefile", 0600);
  close(1);
  dup(fd);
  close(fd);
  execvp(somepgm, someargv);
  fprintf(stderr, "exec failed\n");
  exit(EXIT_FAILURE);
}
/* in parent */
wait(NULL);
```

```
pid = fork();
if (pid == 0)
{ /* in child */
  fd = creat("somefile", 0600);
  close(1);
  dup(fd);
  close(fd);
  execvp(somepgm, someargv);
  fprintf(stderr, "exec failed\n");
  exit(EXIT_FAILURE);
}
/* in parent */
wait(NULL);
```

Parent forks child; child has identical-but distinct file descriptor table 58

Redirection Example Trace (3)

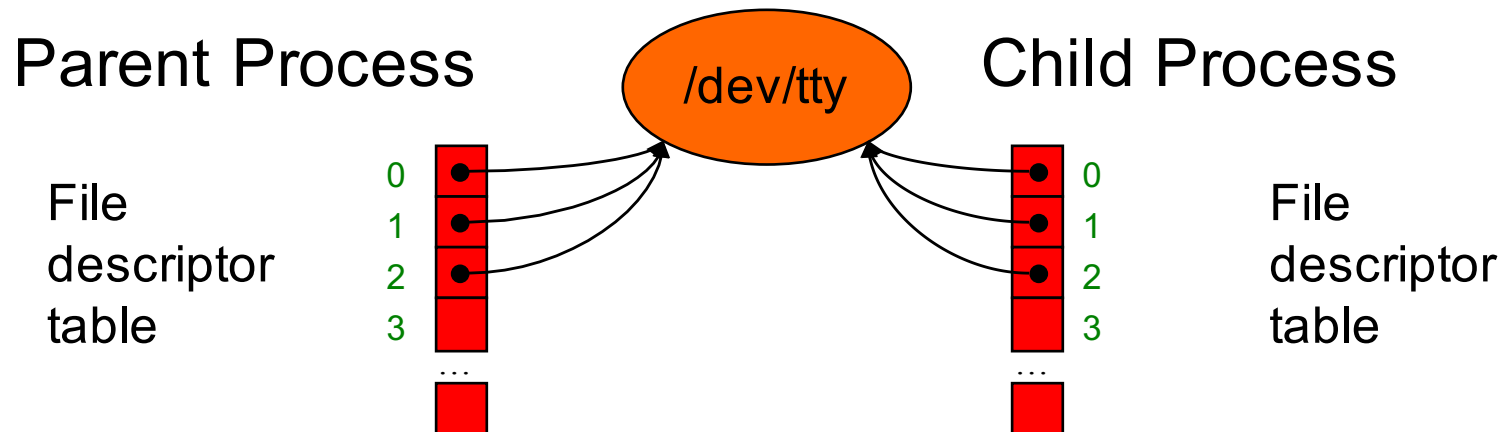

```
pid = fork();
if (pid == 0)
{ /* in child */
  fd = creat("somefile", 0600);
  close(1);
  dup(fd);
  close(fd);
  execvp(somepgm, someargv);
  fprintf(stderr, "exec failed\n");
  exit(EXIT_FAILURE);
}
/* in parent */
wait(NULL);
```

```
pid = fork();
if (pid == 0)
{ /* in child */
  fd = creat("somefile", 060);
  close(1);
  dup(fd);
  close(fd);
  execvp(somepgm, someargv);
  fprintf(stderr, "exec failed\n");
  exit(EXIT_FAILURE);
}
/* in parent */
wait(NULL);
```

Let's say OS gives CPU to parent; parent waits

Redirection Example Trace (4)

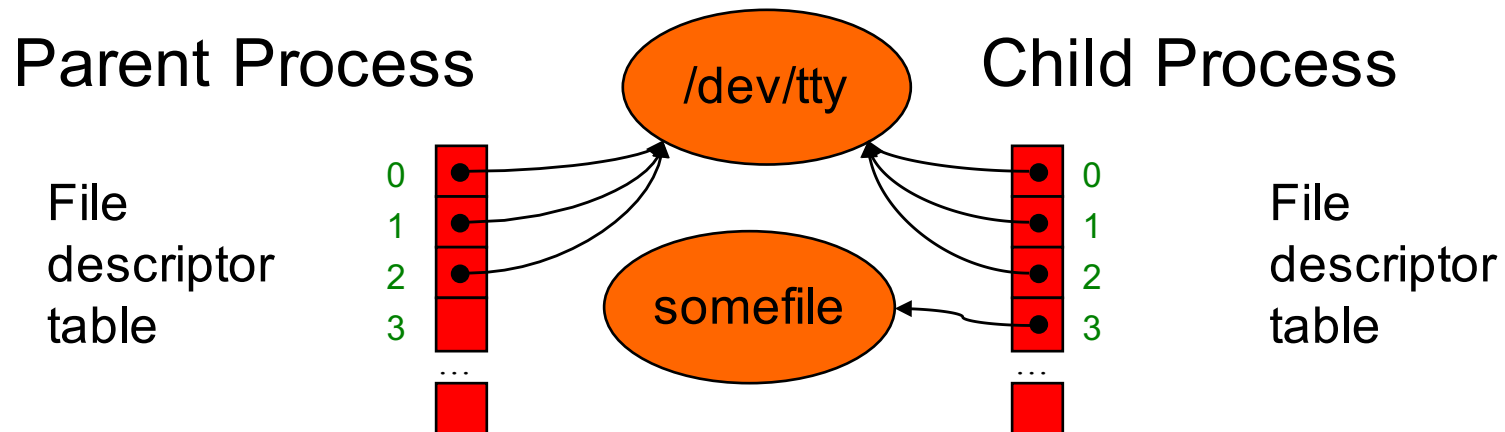

```
pid = fork();
if (pid == 0)
{ /* in child */
  fd = creat("somefile", 0600);
  close(1);
  dup(fd);
  close(fd);
  execvp(somepgm, someargv);
  fprintf(stderr, "exec failed\n");
  exit(EXIT_FAILURE);
}
/* in parent */
wait(NULL);
```

3

```
pid = fork();
if (pid == 0)
{ /* in child */
  fd = creat("somefile", 0600);
  close(1);
  dup(fd);
  close(fd);
  execvp(somepgm, someargv);
  fprintf(stderr, "exec failed\n");
  exit(EXIT_FAILURE);
}
/* in parent */
wait(NULL);
```

OS gives CPU to child; child creates somefile

Redirection Example Trace (5)

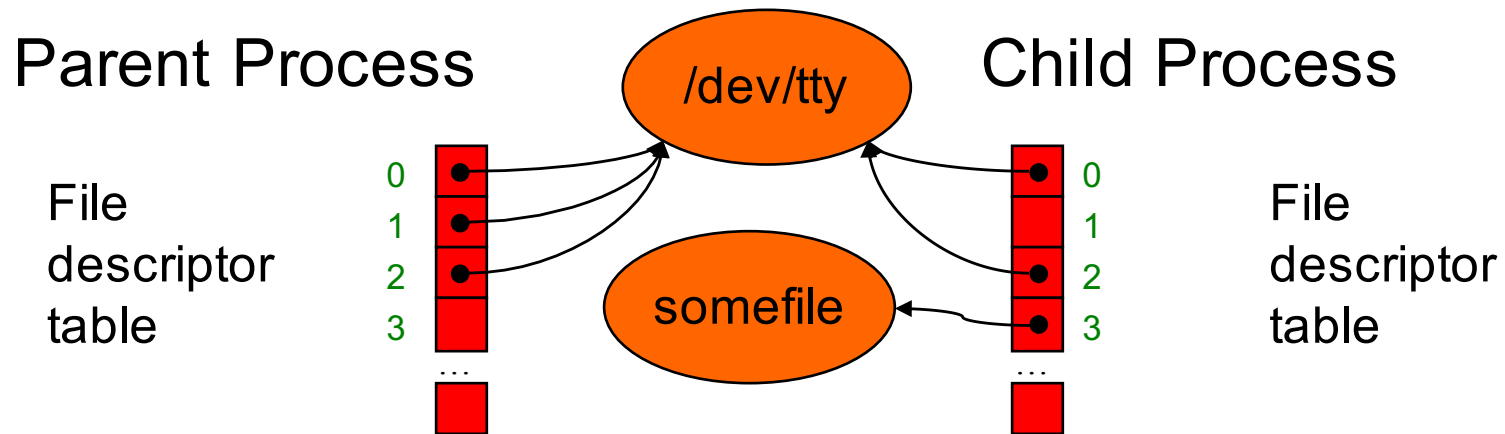

```
pid = fork();
if (pid == 0)
{ /* in child */
  fd = creat("somefile", 0600);
  close(1);
  dup(fd);
  close(fd);
  execvp(somepgm, someargv);
  fprintf(stderr, "exec failed\n");
  exit(EXIT_FAILURE);
}
/* in parent */
wait(NULL);
```

3

```
pid = fork();
if (pid == 0)
{ /* in child */
  fd = creat("somefile", 0600);
  close(1);
  dup(fd);
  close(fd);
  execvp(somepgm, someargv);
  fprintf(stderr, "exec failed\n");
  exit(EXIT_FAILURE);
}
/* in parent */
wait(NULL);
```

Child closes file descriptor 1 (stdout)

Redirection Example Trace (6)

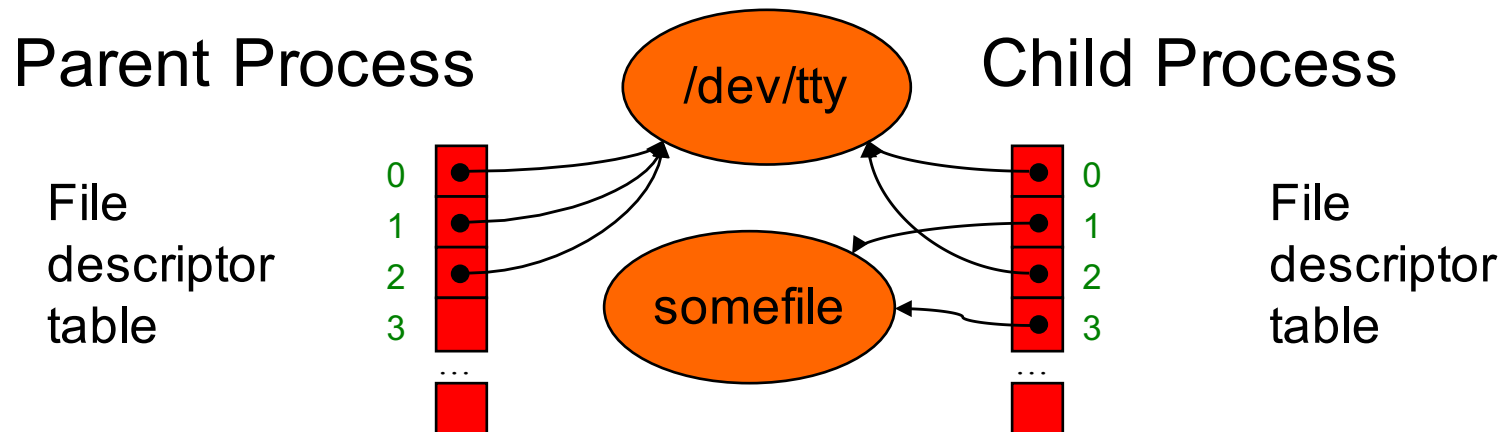

```
pid = fork();
if (pid == 0)
{ /* in child */
  fd = creat("somefile", 0600);
  close(1);
  dup(fd);
  close(fd);
  execvp(somepgm, someargv);
  fprintf(stderr, "exec failed\n");
  exit(EXIT_FAILURE);
}
/* in parent */
wait(NULL);
```

3

```
pid = fork();
if (pid == 0)
{ /* in child */
  fd = creat("somefile", 0600);
  close(1);
  dup(fd);
  close(fd);
  execvp(somepgm, someargv);
  fprintf(stderr, "exec failed\n");
  exit(EXIT_FAILURE);
}
/* in parent */
wait(NULL);
```

Child duplicates file descriptor 3 into first unused spot

Redirection Example Trace (7)

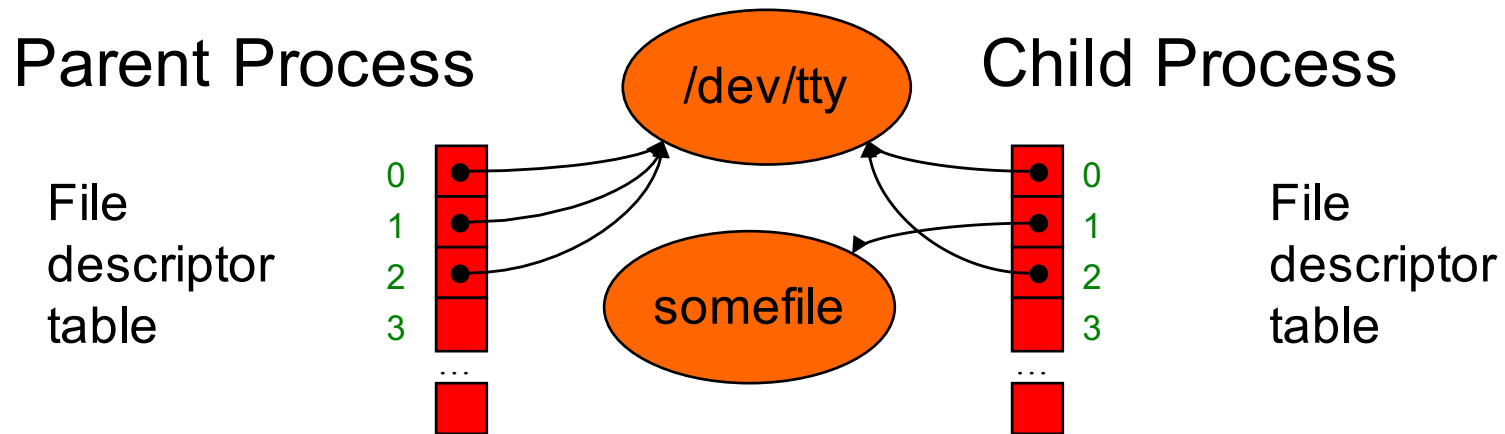

```
pid = fork();
if (pid == 0)
{ /* in child */
  fd = creat("somefile", 0600);
  close(1);
  dup(fd);
  close(fd);
  execvp(somepgm, someargv);
  fprintf(stderr, "exec failed\n");
  exit(EXIT_FAILURE);
}
/* in parent */
wait(NULL);
```

```
pid = fork();
if (pid == 0)
{ /* in child */
  fd = creat("somefile", 0600);
  close(1);
  dup(fd);
  close(fd);
  execvp(somepgm, someargv);
  fprintf(stderr, "exec failed\n");
  exit(EXIT_FAILURE);
}
/* in parent */
wait(NULL);
```

Child closes file descriptor 3

Redirection Example Trace (8)

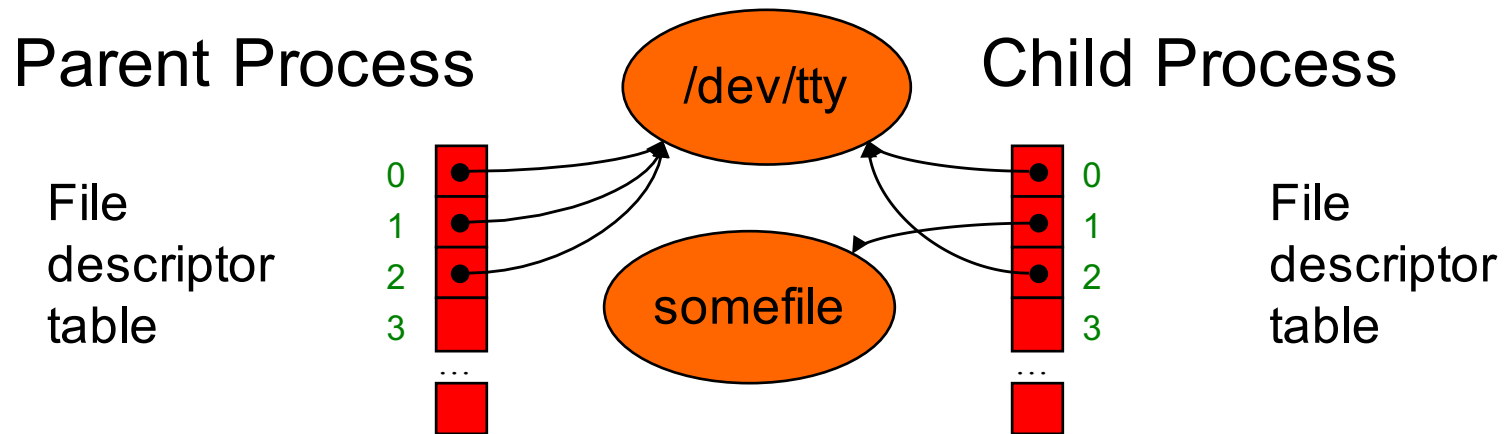

```
pid = fork();
if (pid == 0)
{ /* in child */
  fd = creat("somefile", 0600);
  close(1);
  dup(fd);
  close(fd);
  execvp(somepgm, someargv);
  fprintf(stderr, "exec failed\n");
  exit(EXIT_FAILURE);
}
/* in parent */
wait(NULL);
```

Child calls `execvp()`

```
pid = fork();
if (pid == 0)
{ /* in child */
  fd = creat("somefile", 0600);
  close(1);
  dup(fd);
  close(fd);
  execvp(somepgm, someargv);
  fprintf(stderr, "exec failed\n");
  exit(EXIT_FAILURE);
}
/* in parent */
wait(NULL);
```

Redirection Example Trace (9)

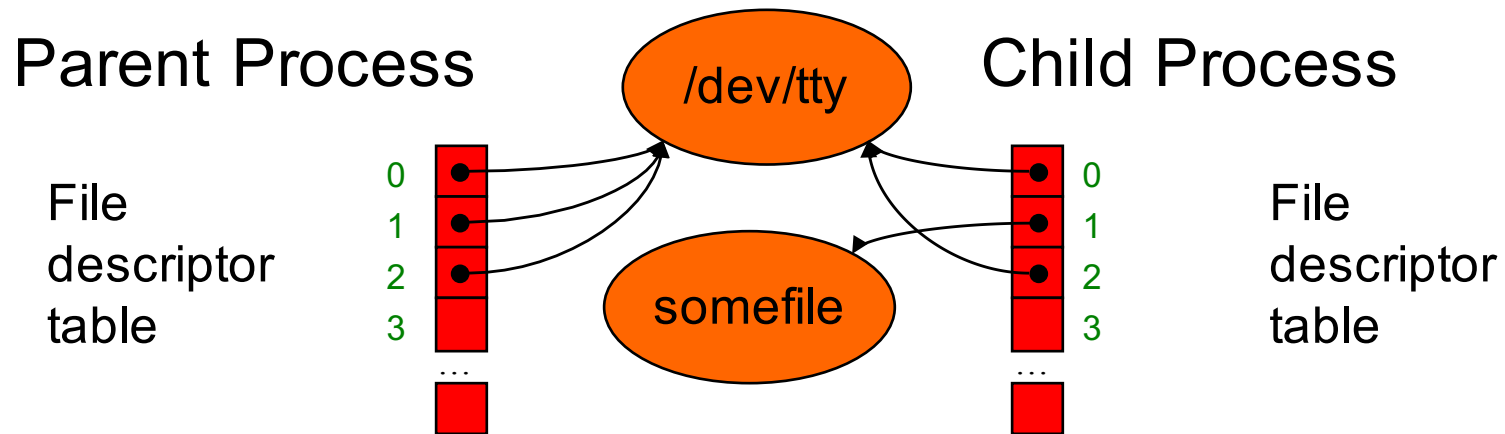

```
pid = fork();
if (pid == 0)
{ /* in child */
  fd = creat("somefile", 0600);
  close(1);
  dup(fd);
  close(fd);
  execvp(somepgm, someargv);
  fprintf(stderr, "exec failed\n");
  exit(EXIT_FAILURE);
}
/* in parent */
wait(NULL);
```

somepgm

Somepgm executes with stdout redirected to somefile

Redirection Example Trace (10)



Parent Process

File
descriptor
table

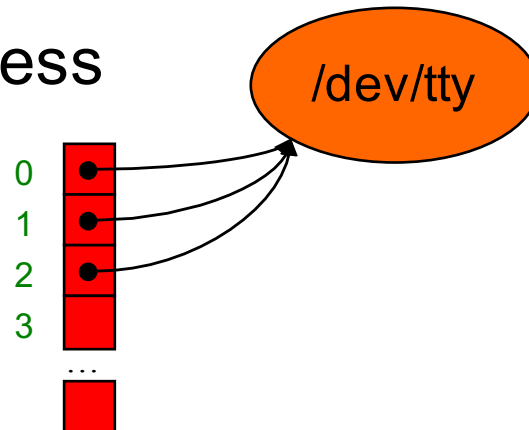

```
pid = fork();
if (pid == 0)
{ /* in child */
  fd = creat("somefile", 0600);
  close(1);
  dup(fd);
  close(fd);
  execvp(somefile, someargv);
  fprintf(stderr, "exec failed\n");
  exit(EXIT_FAILURE);
}
/* in parent */
wait(NULL);
```

Somepgm exits; parent returns from `wait()` and proceeds

Agenda



The C/Unix file abstraction

Unix I/O system calls

C's Standard IO library (FILE *)

Implementing standard C I/O using Unix I/O

Redirecting standard files

Pipes

Inter-Process Communication (IPC)

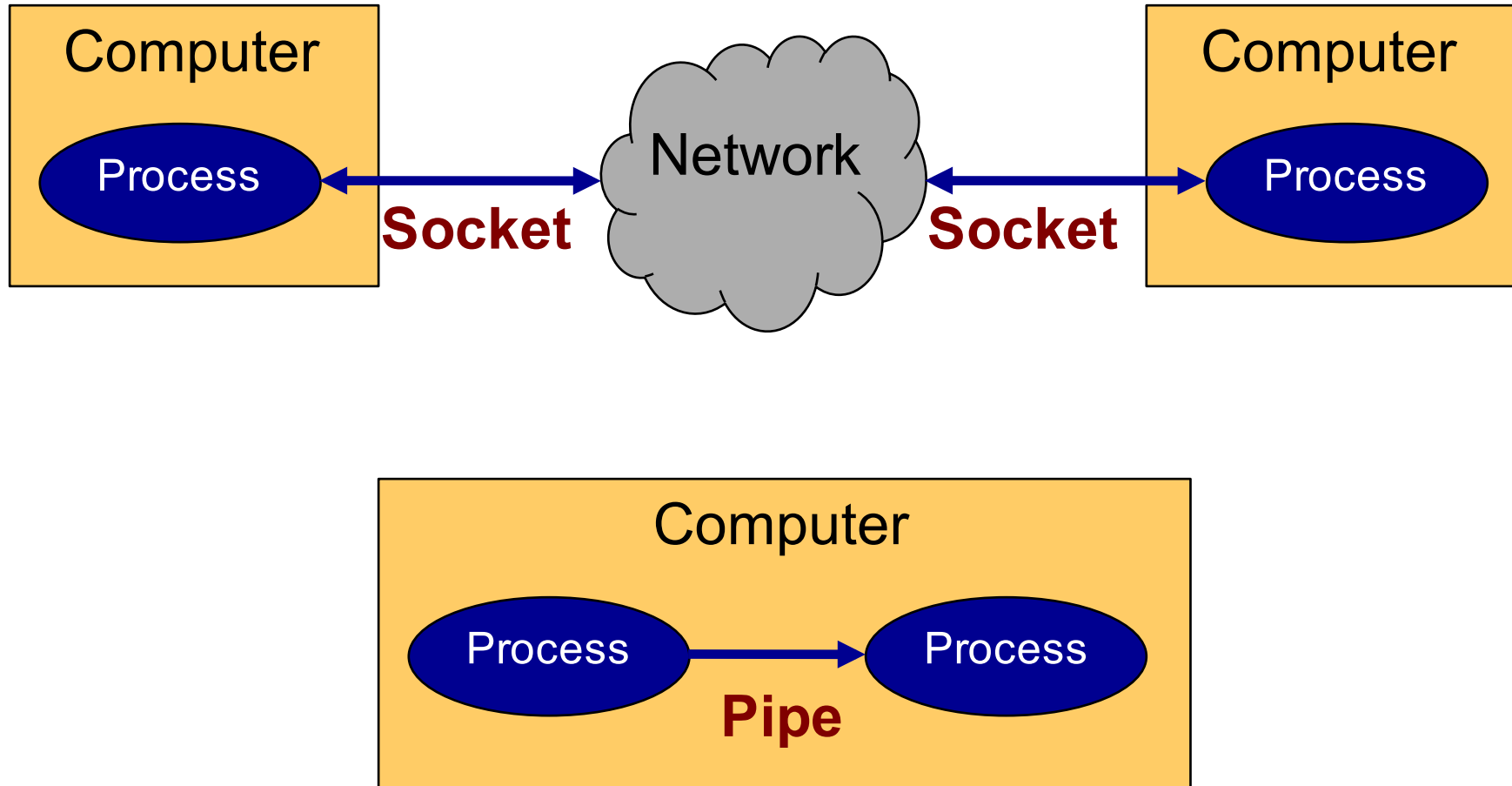

IPC Mechanisms



Socket

- Mechanism for **two-way** communication between processes on **any computers** on same network
- Processes created independently
- Used for client/server communication (e.g., Web)

Pipe

- Mechanism for **one-way** communication between processes on the **same computer**
- Allows parent process to communicate with child process
- Allows two “sibling” processes to communicate
- Used mostly for a **pipeline** of **filters**

Both support **file** abstraction

Pipes, Filters, and Pipelines



Pipe



Filter: Program that reads from stdin and writes to stdout

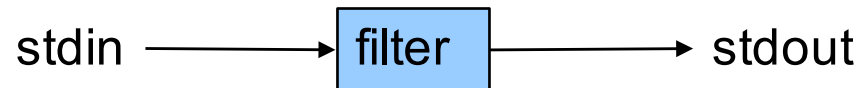

Pipeline: Combination of pipes and filters

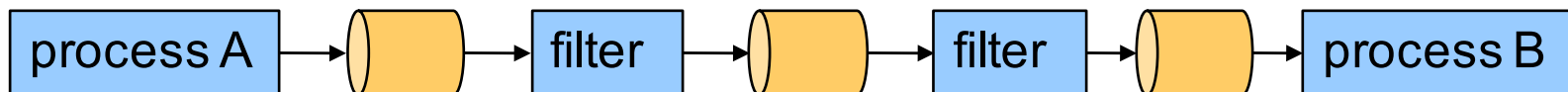

Pipeline Examples



When debugging your shell program...

```
grep alloc *.c
```

- In all of the .c files in the working directory, display all lines that contain “alloc”

```
cat *.c | decomment | grep alloc
```

- In all of the .c files in the working directory, display all non-comment lines that contain “alloc”

```
cat *.c | decomment | grep alloc | more
```

- In all of the .c files in the working directory, display all non-comment lines that contain “alloc”, one screen at a time

Creating a Pipe



```
int pipe(int pipefd[2])
```

- `pipe()` creates a pipe, a unidirectional data channel that can be used for interprocess communication
- The array `pipefd` is used to return two file descriptors referring to the ends of the pipe
- `pipefd[0]` refers to the read end of the pipe
- `pipefd[1]` refers to the write end of the pipe
- Data written to the write end of the pipe is buffered by the kernel until it is read from the read end of the pipe
- Quoting `man -s2 pipe`

Pipe Example 1 (1)



Parent process sends data to child process

```
int p[2];
...
pipe(p)
pid = fork();
if (pid == 0)
{ /* in child */
  close(p[1]);
  /* Read from fd p[0] */
  exit(0);
}
/* in parent */
close(p[0]);
/* Write to fd p[1] */
wait(NULL);
```

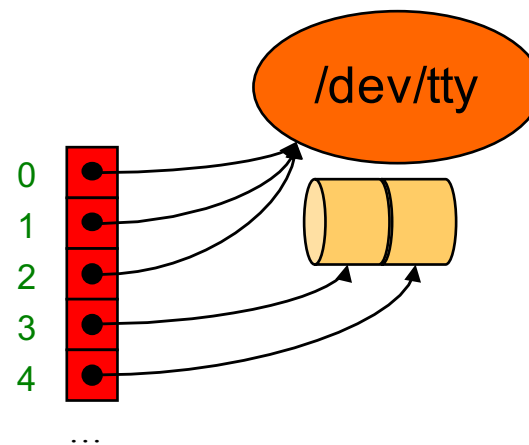

p[0] = 4
p[1] = 3

Pipe Example 1 (2)



Parent process sends data to child process

```
int p[2];
...
pipe(p)
pid = fork();
if (pid == 0)
{ /* in child */
  close(p[1]);
  /* Read from fd p[0] */
  exit(0);
}
/* in parent */
close(p[0]);
/* Write to fd p[1] */
wait(NULL);
```

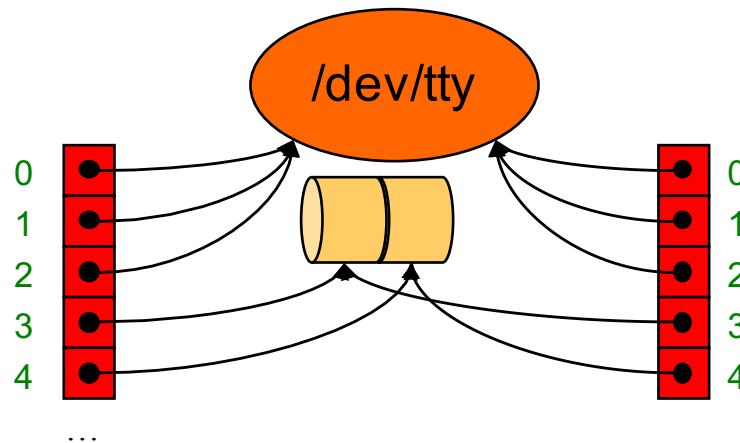

p[0] = 4
p[1] = 3

```
int p[2];
...
pipe(p)
pid = fork();
if (pid == 0)
{ /* in child */
  close(p[0]);
  /* Write to fd p[1] */
  exit(0);
}
/* in parent */
close(p[1]);
/* Read from fd [0] */
wait(NULL);
```

Pipe Example 1 (3)



Parent process sends data to child process

```
int p[2];
...
pipe(p)
pid = fork();
if (pid == 0)
{ /* in child */
  close(p[1]);
  /* Read from fd p[0] */
  exit(0);
}
/* in parent */
close(p[0]);
/* Write to fd p[1] */
wait(NULL);
```

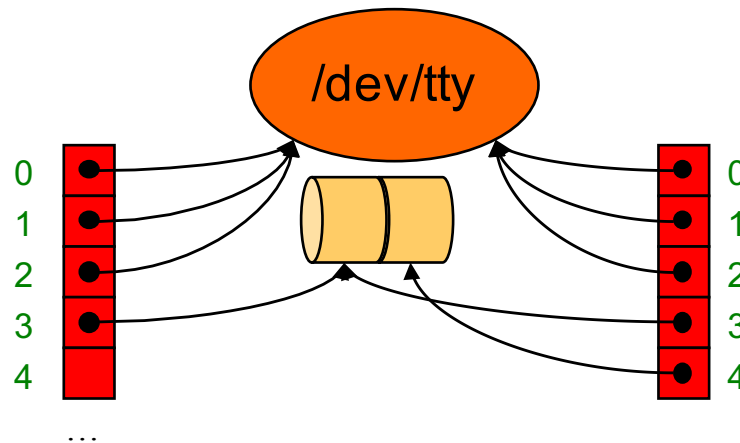

p[0] = 4
p[1] = 3

```
int p[2];
...
pipe(p)
pid = fork();
if (pid == 0)
{ /* in child */
  close(p[1]);
  /* Read from fd p[0] */
  exit(0);
}
/* in parent */
close(p[0]);
/* Write to fd p[1] */
wait(NULL);
```

Pipe Example 1 (4)



Parent process sends data to child process

```
int p[2];
...
pipe(p)
pid = fork();
if (pid == 0)
{ /* in child */
  close(p[1]);
  /* Read from fd p[0] */
  exit(0);
}
/* in parent */
close(p[0]);
/* Write to fd p[1] */
wait(NULL);
```

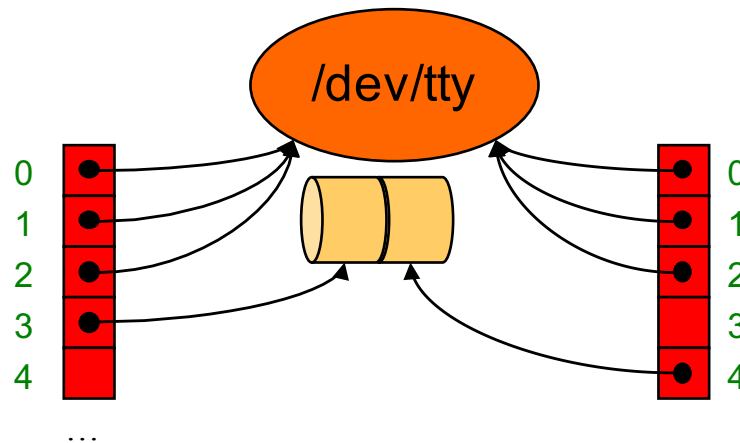

p[0] = 4
p[1] = 3

```
int p[2];
...
pipe(p)
pid = fork();
if (pid == 0)
{ /* in child */
  close(p[1]);
  /* Read from fd p[0] */
  exit(0);
}
/* in parent */
close(p[0]);
/* Write to fd p[1] */
wait(NULL);
```

Pipe Example 2 (1)



Parent process sends data to child process using standard C functions

```
int p[2];  
...  
pipe(p)  
pid = fork();  
if (pid == 0)  
{ /* in child */  
  close(0);  
  dup(p[0]);  
  close(p[0]);  
  close(p[1]);  
  /* Read from stdin */  
  exit(0);  
}  
/* in parent */  
close(1);  
dup(p[1])  
close(p[1]);  
close(p[0]);  
/* write to stdout */  
wait(NULL);
```

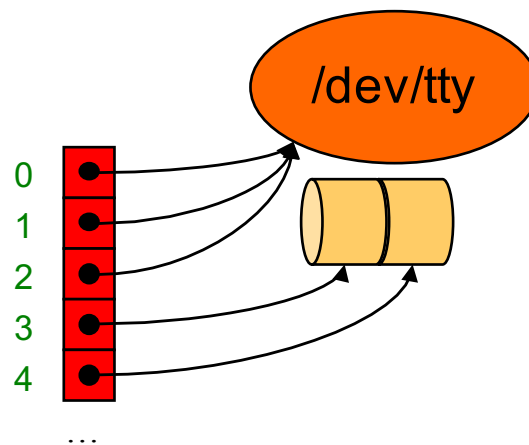

p[0] = 4
p[1] = 3

Pipe Example 2 (2)



Parent process sends data to child process using standard C functions

```
int p[2];
...
pipe(p)
pid = fork();
if (pid == 0)
{ /* in child */
  close(0);
  dup(p[0]);
  close(p[0]);
  close(p[1]);
  /* Read from stdin */
  exit(0);
}
/* in parent */
close(1);
dup(p[1])
close(p[1]);
close(p[0]);
/* write to stdout */
wait(NULL);
```

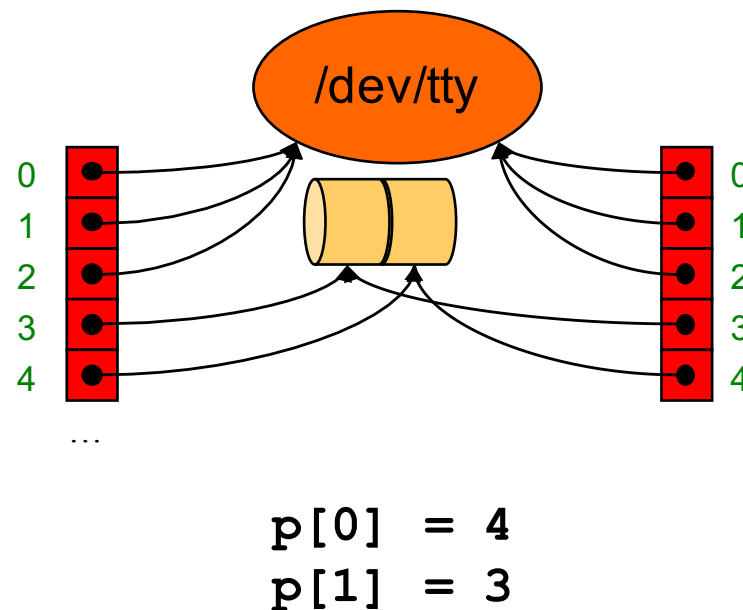

```
int p[2];
...
pipe(p)
pid = fork();
if (pid == 0)
{ /* in child */
  close(0);
  dup(p[0]);
  close(p[0]);
  close(p[1]);
  /* Read from stdin */
  exit(0);
}
/* in parent */
close(1);
dup(p[1])
close(p[1]);
close(p[0]);
/* write to stdout */
wait(NULL);
```

Pipe Example 2 (3)



Parent process sends data to child process using standard C functions

```
int p[2];
...
pipe(p)
pid = fork();
if (pid == 0)
{ /* in child */
  close(0);
  dup(p[0]);
  close(p[0]);
  close(p[1]);
  /* Read from stdin */
  exit(0);
}
/* in parent */
close(1);
dup(p[1])
close(p[1]);
close(p[0]);
/* write to stdout */
wait(NULL);
```

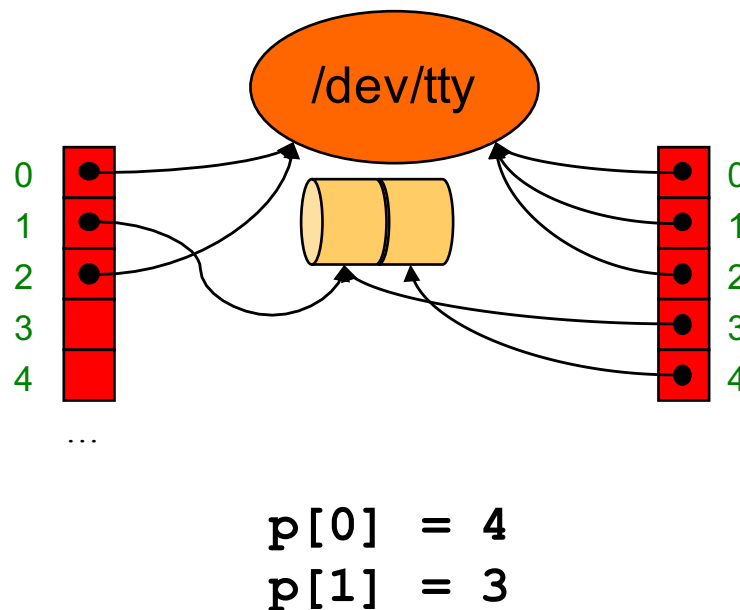

```
int p[2];
...
pipe(p)
pid = fork();
if (pid == 0)
{ /* in child */
  close(0);
  dup(p[0]);
  close(p[0]);
  close(p[1]);
  /* Read from stdin*/
  exit(0);
}
/* in parent */
close(1);
dup(p[1])
close(p[1]);
close(p[0]);
/* write to stdout */
wait(NULL);
```

Pipe Example 2 (4)



Parent process sends data to child process using standard C functions

```
int p[2];
...
pipe(p)
pid = fork();
if (pid == 0)
{ /* in child */
  close(0);
  dup(p[0]);
  close(p[0]);
  close(p[1]);
  /* Read from stdin */
  exit(0);
}
/* in parent */
close(1);
dup(p[1])
close(p[1]);
close(p[0]);
/* write to stdout */
wait(NULL);
```

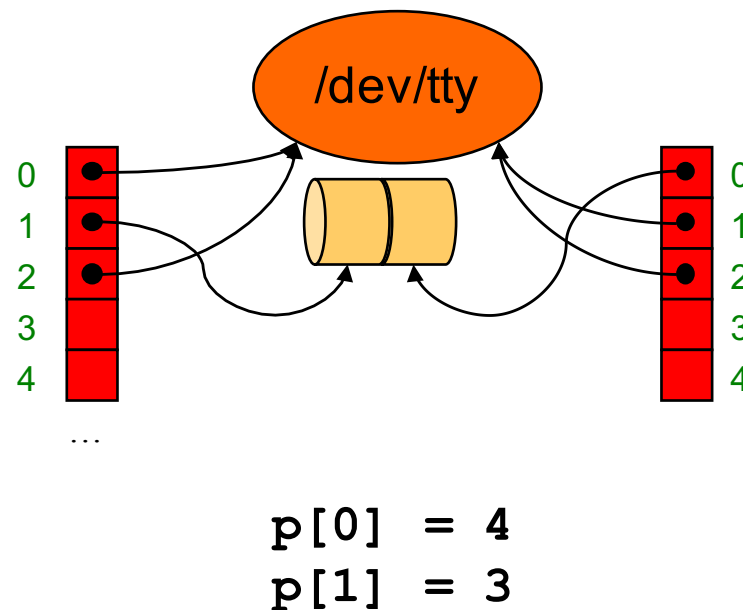

```
int p[2];
...
pipe(p)
pid = fork();
if (pid == 0)
{ /* in child */
  close(0);
  dup(p[0]);
  close(p[0]);
  close(p[1]);
  /* Read from stdin */
  exit(0);
}
/* in parent */
close(1);
dup(p[1])
close(p[1]);
close(p[0]);
/* write to stdout */
wait(NULL);
```

Summary



The C/Unix file abstraction

Unix I/O

- File descriptors, file descriptor tables, file tables
- `creat()`, `open()`, `close()`, `read()`, `write()`, `lseek()`

C's Standard I/O

- `FILE` structure
- `fopen()`, `fclose()`, `fgetc()`, `fputc()`, ...

Implementing standard C I/O using Unix I/O

- Buffering

Redirecting standard files

- `dup()`

Pipes

- `pipe()`